

2.7

Manifold Plates

R _ _



Common connection to port 1 (pressure).

The following valves can be assembled to the manifold plate type R _ _:

- MH 312 port 2: M5
- MH 314 port 2: pif 4 mm
- MH 315 port 2: G 1/8"
- MH 316 port 2: pif 6 mm

All the valves are displayed on page 2.5.1.2.2.

Blanking plates are also available type BP 3.

All the manifold plates offered by Hafner-Pneumatik can be equipped with the DIN-rail mounting clips.

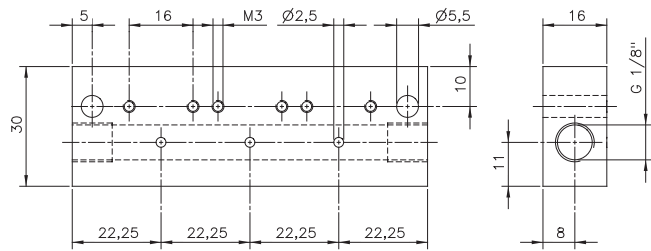

R _ _ Orifice size: 8,5 mm

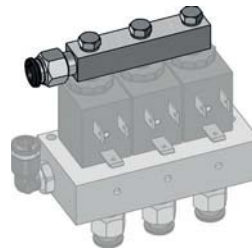

Exhaust rail - RS 03

Available on request:

Exhaust rail to collect the exhausting air at the operator tube. Please ask for our type RS _ _ . Please add two digits for the number of positions required. Push-in fitting not included.

Stations	Type	Weight	Availability
1	R 01	0,05 kg	from stock
2	R 02	0,08 kg	from stock
3	R 03	0,11 kg	from stock
4	R 04	0,13 kg	from stock
5	R 05	0,16 kg	from stock
6	R 06	0,19 kg	from stock
7	R 07	0,21 kg	from stock
8	R 08	0,24 kg	from stock
9	R 09	0,27 kg	from stock
10	R 10	0,30 kg	from stock
11	R 11	0,32 kg	from stock
12	R 12	0,35 kg	from stock
13	R 13	0,38 kg	from stock
14	R 14	0,41 kg	from stock
15	R 15	0,44 kg	from stock
16	R 16	0,47 kg	from stock

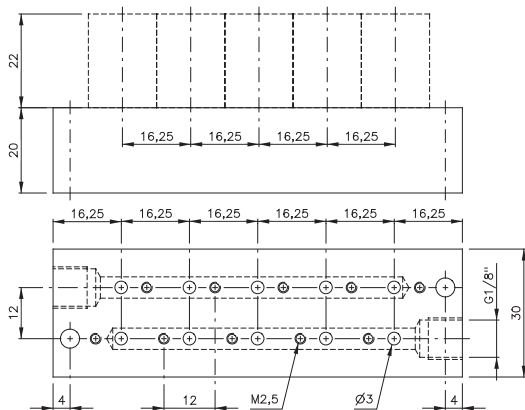

RD 3__ 303 Orifice size: 5 mm

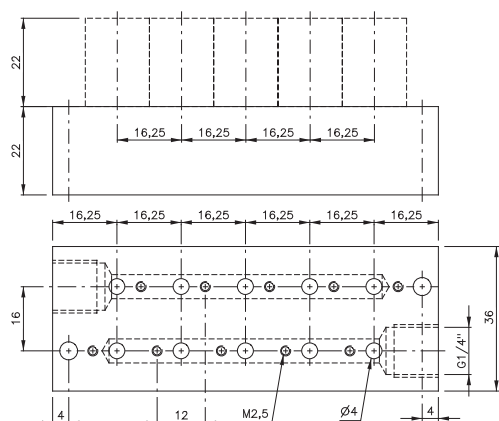

RD 3__ 403 Orifice size: 6 mm



Common connection to port 1 (pressure) and 3 (exhaust).

The following valves can be assembled to the manifold plate type **RD 3__ 303**:

3/2-way n.c.	pif 4 mm	MD 310 343	page 2.5.1.2.4
3/2-way n.o.	pif 4 mm	MOD 310 343	page 2.5.1.2.4

Blanking plates are also available type BP 3 303.

The following valves can be assembled to the manifold plate type **RD 3__ 403**:

3/2-way n.c.	G 1/8"	MD 310 403	page 2.5.1.2.4
3/2-way n.o.	G 1/8"	MOD 310 403	page 2.5.1.2.4
3/2-way n.c.	pif 6 mm	MD 310 463	page 2.5.1.2.4
3/2-way n.o.	pif 6 mm	MOD 310 463	page 2.5.1.2.4

Blanking plates are also available type BP 3 403.

Please note:

Due to the compact design of the plate if a larger number of valves are to switch at the same time please do not select plates with more than 6 stations.

Stations	Type	Weight	Availability	Type	Weight	Availability
2	RD 302 303	0,07 kg	from stock	RD 302 403	0,09 kg	from stock
3	RD 303 303	0,10 kg	from stock	RD 303 403	0,13 kg	from stock
4	RD 304 303	0,13 kg	from stock	RD 304 403	0,16 kg	from stock
5	RD 305 303	0,15 kg	from stock	RD 305 403	0,19 kg	from stock
6	RD 306 303	0,18 kg	from stock	RD 306 403	0,23 kg	from stock
7	RD 307 303	0,21 kg	on request	RD 307 403	0,27 kg	on request
8	RD 308 303	0,23 kg	from stock	RD 308 403	0,30 kg	from stock
9	RD 309 303	0,26 kg	on request	RD 309 403	0,33 kg	on request
10	RD 310 303	0,28 kg	from stock	RD 310 403	0,36 kg	from stock
12	RD 312 303	0,33 kg	from stock	RD 312 403	0,43 kg	from stock
14	RD 314 303	0,38 kg	on request	RD 314 403	0,49 kg	on request
16	RD 316 303	0,43 kg	on request	RD 316 403	0,55 kg	on request

RD 3__ 344/RD 3__ 464



Common connection to port 1 (pressure) and 3 (exhaust). The individual ports 2 are also in the manifold plate equipped with push-in fittings.

The following valves can be assembled to the manifold plate type **RD 3__ 344** (pif 4 mm):

- 3/2-way n.c. MD 310 304 page 2.5.1.2.5
- 3/2-way n.o. MOD 310 304 page 2.5.1.2.5

Blanking plates are also available type BP 3 304.

The following valves can be assembled to the manifold plate type **RD 3__ 464** (pif 6 mm):

- 3/2-way n.c. MD 310 404 page 2.5.1.2.5
- 3/2-way n.o. MOD 310 404 page 2.5.1.2.5

Blanking plates are also available type BP 3 404.

Please note:

Due to the compact design of the plate if a larger number of valves are to switch at the same time please do not select plates with more than 6 stations.

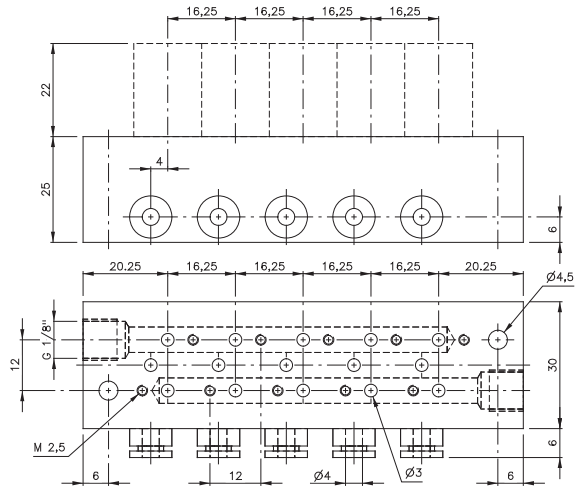

RD 3__ 344 Orifice size: 5 mm

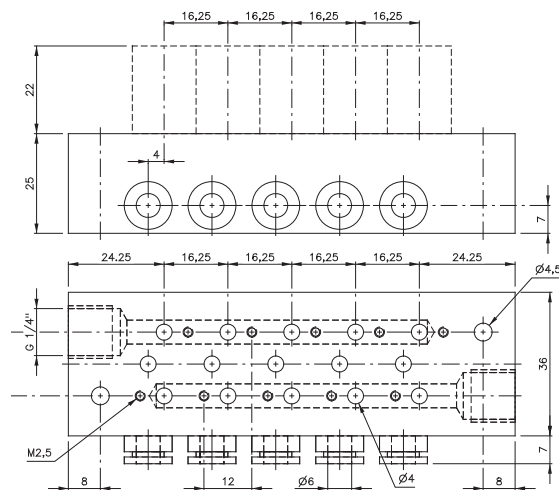

RD 3__ 464 Orifice size: 6 mm

Stations	Type	Weight	Availability	Type	Weight	Availability
2	RD 302 344	0,13 kg	from stock	RD 302 464	0,15 kg	from stock
3	RD 303 344	0,16 kg	from stock	RD 303 464	0,19 kg	from stock
4	RD 304 344	0,19 kg	from stock	RD 304 464	0,23 kg	from stock
5	RD 305 344	0,22 kg	from stock	RD 305 464	0,26 kg	from stock
6	RD 306 344	0,25 kg	from stock	RD 306 464	0,30 kg	from stock
7	RD 307 344	0,28 kg	on request	RD 307 464	0,34 kg	on request
8	RD 308 344	0,31 kg	from stock	RD 308 464	0,38 kg	from stock
9	RD 309 344	0,34 kg	on request	RD 309 464	0,41 kg	on request
10	RD 310 344	0,38 kg	from stock	RD 310 464	0,49 kg	from stock
12	RD 312 344	0,44 kg	from stock	RD 312 464	0,53 kg	from stock
14	RD 314 344	0,50 kg	on request	RD 314 464	0,60 kg	from stock
16	RD 316 344	0,56 kg	on request	RD 316 464	0,68 kg	on request

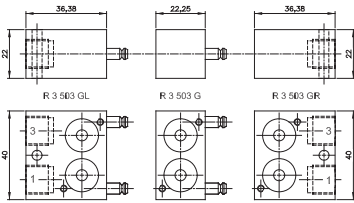

Parts of modular manifold RB 3__ 503 G

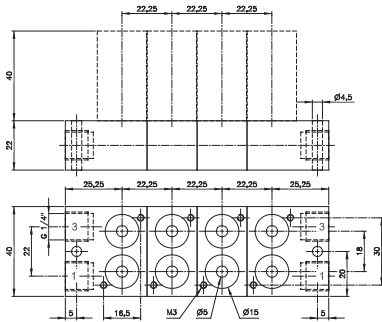

RB 3__ 503 G Orifice size: 10 mm

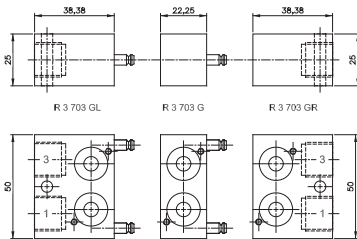

Parts of modular manifold RB 3__ 703 G

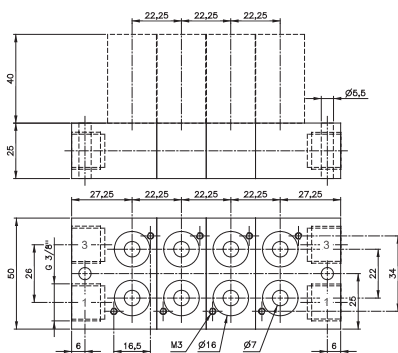

RB 3__ 703 G Orifice size: 15 mm



BS 503/BS 3 703

By adding a special plug (type BS 503/BS 3 703), two different pressures can be attached at the same manifold plate. The plug is intercepting the air-supply in the manifold plate wherever the customer likes to. Type BS 503 for manifold RB_503 G and BS 3 703 for manifold RB_703 G.



Modular manifold system for common connections to ports 1 (pressure) and 3 (exhaust). The system can be build and taken apart just by operating two hexagon socket screws. Additional stations can be added at any position and any time. End-plates are equipped with threads for adding DIN-rail mounting clips.

The following valves can be assembled to the system **RB 3__ 503 G**:

3/2 single sol. n.c.	G 1/8"	MH 310 501 G	page 2.5.1.1.16
3/2 single sol. n.o.	G 1/8"	MOH 310 501 G	page 2.5.1.1.16
3/2 double sol.	G 1/8"	MH 320 501 G	page 2.5.1.1.20

The system consists of:

End-plate right	type R 3 503 GR
End-plate left	type R 3 503 GL
Individual position	type R 3 503 G

Blanking plates are also available type BP 3 503.

The following valves can be assembled to the system **RB 3__ 703 G**:

3/2 single sol. n.c.	G 1/4"	MH 310 701 G	page 2.5.1.1.16
3/2 single sol. n.o.	G 1/4"	MOH 310 701 G	page 2.5.1.1.16
3/2 double sol.	G 1/4"	MH 320 701 G	page 2.5.1.1.20

The system consists of:

End-plate right	type R 3 703 GR
End-plate left	type R 3 703 GL
Individual position	type R 3 703 G

Blanking plates are also available type BP 3 703.

The plates can also be ordered assembled by the manufacturer. In this case order RB 3__ 503 G (1/8") or RB 3__ 703 G (1/4"). Please add two digits for the number of positions required.

Type	Function	Weight
R 3 503 GR	End-plate right	0,07 kg
R 3 503 GL	End-plate left	0,07 kg
R 3 503 G	Individual position	0,05 kg

Type	Function	Weight
R 3 703 GR	End-plate right	0,11 kg
R 3 703 GL	End-plate left	0,11 kg
R 3 703 G	Individual position	0,07 kg
R 3 703 G D1	Individual position, with individual valve isolation	0,08 kg

RB 3__ 103 G/R 3__ 121 G

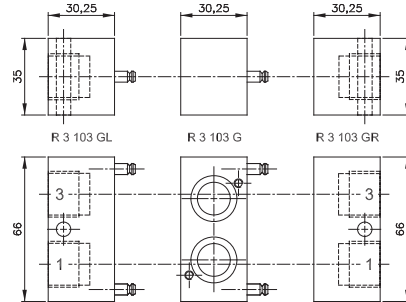

Parts of modular manifold **RB 3__ 103 G**

Series 103 G modular manifold system for common connections to ports 1 (pressure) and 3 (exhaust). The system can be build and taken apart just by operating two hexagon socket screws. Additional stations can be added at any position and any time. End-plates are equipped with threads for adding DIN-rail mounting clips.

The following valves can be assembled to the system

RB 3__ 103 G:

- | | | |
|----------------------|----------------------|-----------------|
| 3/2 single sol. n.c. | G 3/8" MH 310 101 G | page 2.5.1.1.17 |
| 3/2 single sol. n.o. | G 3/8" MOH 310 101 G | page 2.5.1.1.17 |
| 3/2 double sol. | G 3/8" MH 320 101 G | page 2.5.1.1.20 |

The system consists of:

- End-plate right type R 3 103 GR
- End-plate left type R 3 103 GL
- Individual position type R 3 103 G

Blanking plates are also available type BP 3 103.

Please note:

- End-plates of series 103 G are not offering an individual valve position.
- The plates can also be ordered assembled by the manufacturer. In this case order RB 3__ 103 G (3/8").
- Please add two digits for the number of positions required.

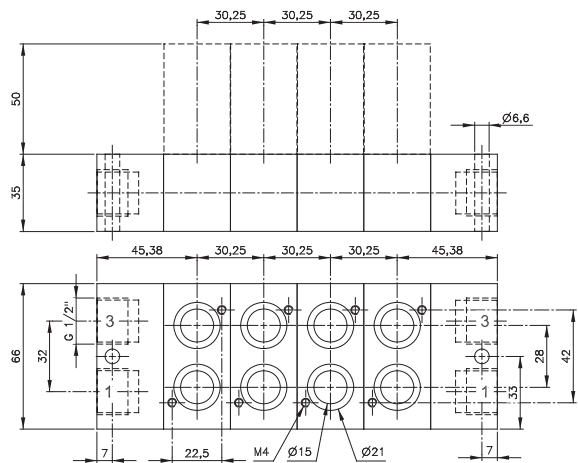

RB 3__ 103 G Orifice size: 19 mm

Series 121 G solid manifold system for common connections to ports 1 (pressure) and 3 (exhaust).

The following valves can be assembled to the manifold plate type **R 3__ 121 G:**

Solenoid valves:

- | | | |
|-----------------------|----------------------|-----------------|
| 3/2 single sol. n.c. | G 1/2" MH 310 121 G | page 2.5.1.1.17 |
| 3/2 single sol. n.o. | G 1/2" MOH 310 121 G | page 2.5.1.1.17 |
| 3/2 double sol. | G 1/2" MH 320 121 G | page 2.5.1.1.20 |
| 3/3-way centre closed | G 1/2" MH 331 121 G | page 2.5.1.3 |

Pneumatically actuated 3/2-way valves:

- | | | |
|--------------|--------------------|--------------|
| air spring | G 1/2" P 310 121 G | page 2.4.1.4 |
| mech. spring | G 1/2" P 311 121 G | page 2.4.1.4 |

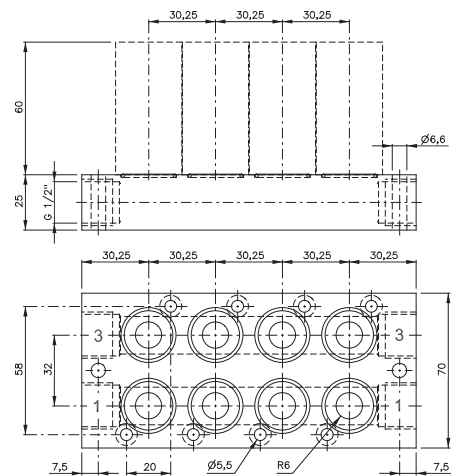

R 3__ 121 G Orifice size: 12 mm

Type	Function	Weight	Type	Weight	Availability
R 3 103 GR	End-plate right	0,14 kg	R 302 121 G	0,28 kg	from stock
R 3 103 GL	End-plate left	0,15 kg			
R 3 103 G	Individual position	0,12 kg	R 304 121 G	0,48 kg	from stock

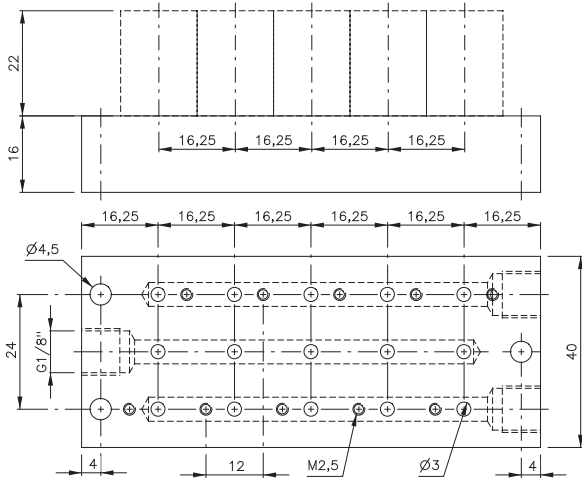

RD 5__ 303 Orifice size: 8 mm

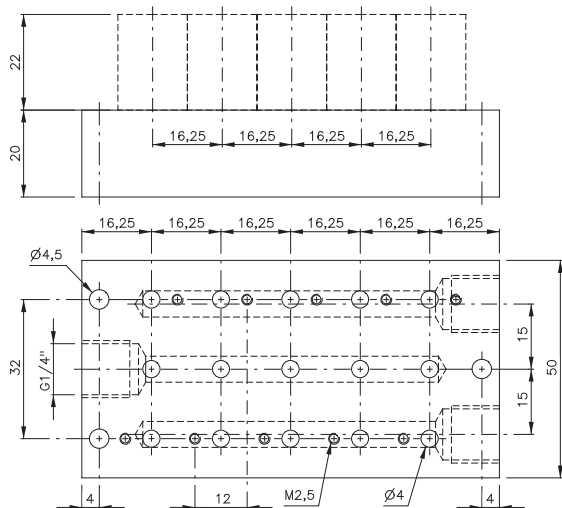

RD 5__ 403 Orifice size: 10 mm



Common connection to port 1 (pressure), 3 and 5 (exhaust).

The following solenoid valves can be assembled to the manifold plate type **RD 5__ 303**:

5/2 single sol.	M5	MD 510 303	page 2.5.2.2.1
5/2 single sol.	pif 4 mm	MD 510 343	page 2.5.2.2.1
5/2 double sol.	M5	MD 520 303	page 2.5.2.2.5
5/2 double sol.	pif 4 mm	MD 520 343	page 2.5.2.2.5
5/3-way	M5	MD 53_ 303	page 2.5.3.2.1
5/3-way	pif 4 mm	MD 53_ 343	page 2.5.3.2.1

Blanking plates are also available type BP 5 303.

The following solenoid valves can be assembled to the manifold plate type **RD 5__ 403**:

5/2 single sol.	G 1/8"	MD 510 403	page 2.5.2.2.1
5/2 single sol.	pif 6 mm	MD 510 463	page 2.5.2.2.1
5/2 double sol.	G 1/8"	MD 520 403	page 2.5.2.2.5
5/2 double sol.	pif 6 mm	MD 520 463	page 2.5.2.2.5
5/3-way	G 1/8"	MD 53_ 403	page 2.5.3.2.1
5/3-way	pif 6 mm	MD 53_ 463	page 2.5.3.2.1

Blanking plates are also available type BP 5 403.

Please note:

Due to the compact design of the plate if a larger number of valves are to switch at the same time please do not select plates with more than 6 stations.

Stations	Type	Weight	Availability	Type	Weight	Availability
2	RD 502 303	0,08 kg	from stock	RD 502 403	0,12 kg	from stock
3	RD 503 303	0,10 kg	from stock	RD 503 403	0,16 kg	from stock
4	RD 504 303	0,13 kg	from stock	RD 504 403	0,20 kg	from stock
5	RD 505 303	0,16 kg	from stock	RD 505 403	0,24 kg	from stock
6	RD 506 303	0,18 kg	from stock	RD 506 403	0,28 kg	from stock
7	RD 507 303	0,21 kg	on request	RD 507 403	0,32 kg	on request
8	RD 508 303	0,24 kg	from stock	RD 508 403	0,37 kg	from stock
9	RD 509 303	0,26 kg	on request	RD 509 403	0,41 kg	on request
10	RD 510 303	0,29 kg	from stock	RD 510 403	0,45 kg	from stock
12	RD 512 303	0,34 kg	from stock	RD 512 403	0,53 kg	from stock
14	RD 514 303	0,39 kg	on request	RD 514 403	0,62 kg	from stock
16	RD 516 303	0,44 kg	on request	RD 516 403	0,69 kg	from stock

RB 5 __ 503 G



Modular manifold system for common connections to ports 1 (pressure), 3 and 5 (exhaust). The system can be build and taken apart just by operating two hexagon socket screws. Additional stations can be added at any position and any time. End-plates are equipped with threads for adding DIN-rail mounting clips.

The following valves can be assembled to the system **RB 5 __ 503 G**:

Solenoid valves:

5/2 single sol.	G 1/8"	MH 510 501 G	page 2.5.2.1.5
5/2 single sol.	G 1/8"	MH 510 503	page 2.5.2.2.2
5/2 double sol.	G 1/8"	MH 520 501 G	page 2.5.2.1.11
5/2 double sol.	G 1/8"	MH 520 503	page 2.5.2.2.6
5/3 solenoid	G 1/8"	MH 53_ 501 G	page 2.5.3.1.4
5/3 solenoid	G 1/8"	MH 53_ 503	page 2.5.3.2.2

Pneumatically actuated valves:

5/2 air spring	G 1/8"	P 510 501 G	page 2.4.2.4
5/2 mech. spring	G 1/8"	P 511 501 G	page 2.4.2.4
5/2 double pilot	G 1/8"	P 52_ 501 G	page 2.4.2.8
5/3	G 1/8"	P 53_ 501 G	page 2.4.3.3

The system consists of:

End-plate right	type R 5 503 GR
End-plate left	type R 5 503 GL
Individual position	type R 5 503 G

Blanking plates are also available type BP 5 503.

The plates can also be ordered assembled by the manufacturer. In this case order RB 5 __ 503 G. Please add two digits for the number of positions required.

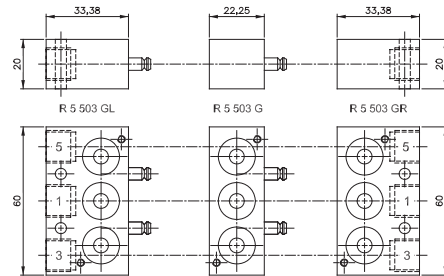

Parts of modular manifold RB 5 __ 503 G

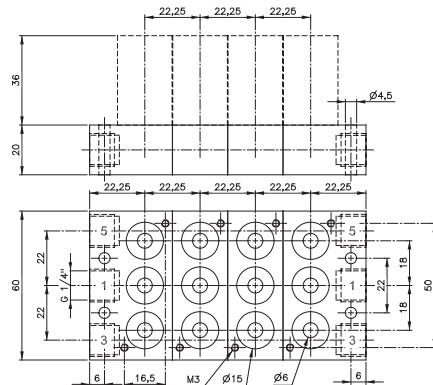

RB 5 __ 503 G Orifice size: 10 mm



BS 503

By adding a special plug (type BS 503), two different pressures can be attached at the same manifold plate. The plug is intercepting the air-supply in the manifold plate wherever the customer likes to.

Type	Function	Weight
R 5 503 GR	End-plate right	0,08 kg
R 5 503 GL	End-plate left	0,08 kg
R 5 503 G	Individual position	0,06 kg

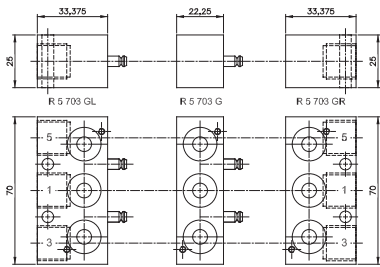

Parts of modular manifold RB 5 __ 703 G

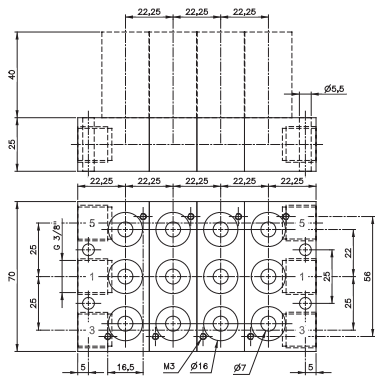

RB 5 __ 703 G Orifice size: 15 mm



1.) Combination of 3- and 5-way valves

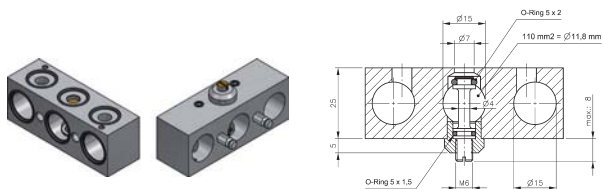

2.) Individual valve isolation (R 5 703 G D1)



BS 703

By adding a special plug (type BS 703), two different pressures can be attached at the same manifold plate. The plug is intercepting the air-supply in the manifold plate wherever the customer likes to.

Modular manifold system for common connections to ports 1 (pressure), 3 and 5 (exhaust). The system can be build and taken apart just by operating two hexagon socket screws. Additional stations can be added at any position and any time. End-plates are equipped with threads for adding DIN-rail mounting clips.

The following valves can be assembled to the system RB 5 __ 703 G:

Solenoid valves:			
5/2 single sol.	G 1/4"	MH 510 701 G	page 2.5.2.1.5
5/2 single sol.	G 1/4"	MH 510 703	page 2.5.2.2.2
5/2 double sol.	G 1/4"	MH 520 701 G	page 2.5.2.1.11
5/2 double sol.	G 1/4"	MH 520 703	page 2.5.2.2.6
5/3 solenoid	G 1/4"	MH 53_701 G	page 2.5.3.1.4
5/3 solenoid	G 1/4"	MH 53_703	page 2.5.3.2.2

Pneumatically actuated valves:			
5/2 air spring	G 1/4"	P 510 701 G	page 2.4.2.4
5/2 mech. spring	G 1/4"	P 511 701 G	page 2.4.2.4
5/2 double pilot	G 1/4"	P 52_701 G	page 2.4.2.8
5/3 pneum.	G 1/4"	P 53_701 G	page 2.4.3.3

The system consists of:
End-plate right type R 5 703 GR
End-plate left type R 5 703 GL
Individual position type R 5 703 G

Blanking plates are also available type BP 5 703.

NPT-ported end-plates available on request.

The plates can also be ordered assembled by the manufacturer. In this case order RB 5 __ 703 G. Please add two digits for the number of positions required.

Additional:
1.) Combine 3-way and 5-way valves on the same plate. By adding R 53 703 G elements to the standard R 5 703 G elements, 3-way as well as 5-way valves can be mixed on the same plate (e.g. MH 510 701 G and MH 310 701 G).

2.) Individual valve isolation.
In certain industries the user appreciates, if he can take away air pressure at any valve on the plate individually. Valves can easily be exchanged by closing port 1 on the reverse side of the plate without interruption of the air-supply of the other valves.

The system consists of:
End-plate right type R 5 703 GR D1
End-plate left type R 5 703 GL D1
Individual position type R 5 703 G D1

Type	Function	Weight
R 5 703 GR	End-plate right	0,13 kg
R 5 703 GL	End-plate left	0,12 kg
R 5 703 G	Individual position	0,09 kg
R 5 703 G D1	Individual position with individual valve isolation	0,09 kg

RB 5 __ 103 G



Modular manifold system for common connections to ports 1 (pressure), 3 and 5 (exhaust). The system can be built and taken apart just by operating two hexagon socket screws. Additional stations can be added at any position and any time. End-plates are equipped with threads for adding DIN-rail mounting clips.

The following valves can be assembled to the system

RB 5 __ 103 G:

5/2 single solenoid	G 3/8"	MH 510 101 G	page 2.5.2.1.6
5/2 double solenoid	G 3/8"	MH 520 101 G	page 2.5.2.1.12
5/3 solenoid	G 3/8"	MH 53_ 101 G	page 2.5.3.1.5

The system consists of:

End-plate right	type R 5 103 GR
End-plate left	type R 5 103 GL
Individual position	type R 5 103 G

Blanking plates are also available type BP 5 103.

Please note:

End-plates are not offering an individual valve-position.

The plates can also be ordered assembled by the manufacturer. In this case order RB 5 __ 103 G. Please add two digits for the number of positions required.

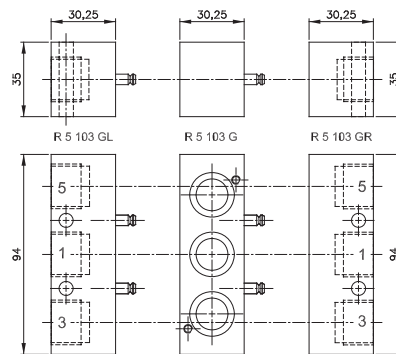

Parts of modular manifold RB 5 __ 103 G

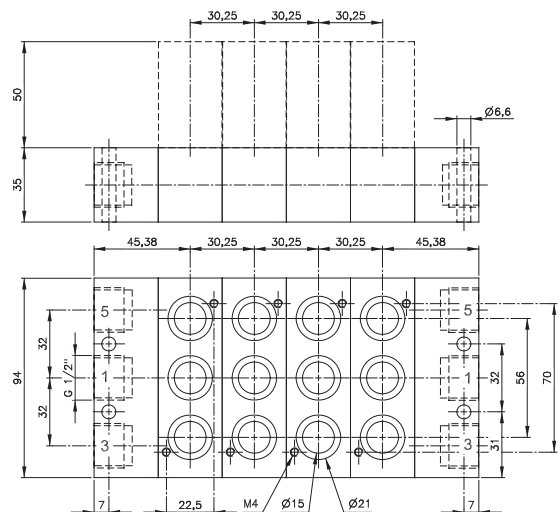

R 5 __ 103 G Orifice size: 19 mm

Type	Function	Weight
R 5 103 GR	End-plate right	0,20 kg
R 5 103 GL	End-plate left	0,21 kg
R 5 103 G	Individual position	0,18 kg

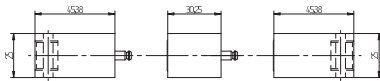

R 5 803 L R 5 803 R 5 803 R

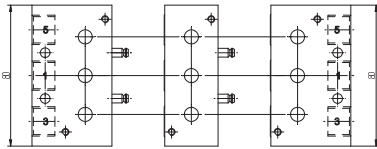

Parts of modular manifold RB 5 __ 803

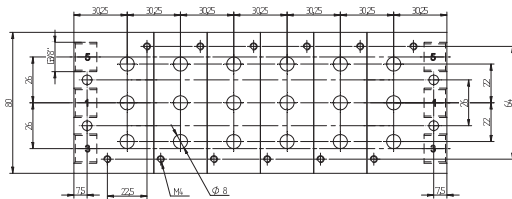
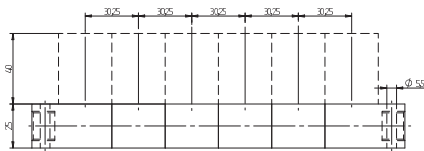

RB 5 __ 803 Orifice size: 15 mm

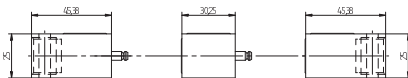

R 5 121 GL R 5 121 G R 5 121 GR

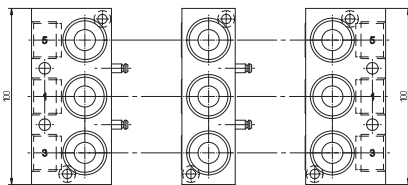

Parts of modular manifold RB 5 __ 121 G

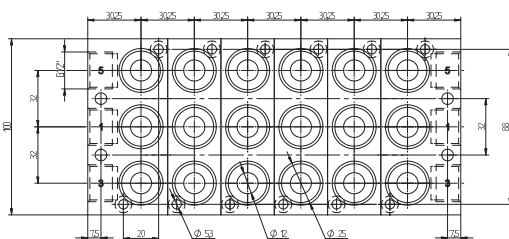
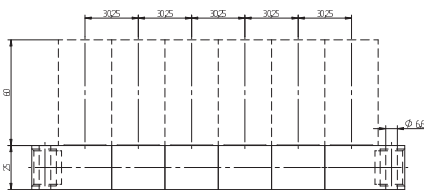

RB 5 __ 121 G Orifice size: 17 mm

Modular manifold system for common connections to ports 1 (pressure), 3 and 5 (exhaust). The system can be build and taken apart just by operating two hexagon socket screws. Additional stations can be added at any position and any time.

The following valves can be assembled to the system **RB 5 __ 803**:

5/2 single sol.	G 1/4"	MH 510 803	page 2.5.2.2.2
5/2 double sol.	G 1/4"	MH 520 803	page 2.5.2.2.6
5/3 solenoid	G 1/4"	MH 53_ 803	page 2.5.3.2.2

The system consists of:

End-plate right	type R 5 803 R
End-plate left	type R 5 803 L
Individual position	type R 5 803

Blanking plates are also available type BP 5 803.

The following valves can be assembled to the system **RB 5 __ 121 G**:

Solenoid valves:

5/2 single sol.	G 1/2"	MH 510 121 G	page 2.5.2.1.6
5/2 double sol.	G 1/2"	MH 520 121 G	page 2.5.2.1.12
5/3 solenoid	G 1/2"	MH 53_ 121 G	page 2.5.3.1.5

Pneumatically actuated valves :

5/2 single pilot	G 1/2"	P 510 121 G	page 2.4.2.4
5/2 double pilot	G 1/2"	P 520 121 G	page 2.4.2.8
5/3 pneumatic	G 1/2"	P 53_ 121 G	page 2.4.3.3

Blanking plates are also available type BP 5 121 G.

The system consists of:

End-plate right	type R 5 121 GR
End-plate left	type R 5 121 GL
Individual position	type R 5 121 G

The plates can also be ordered assembled by the manufacturer. In this case order RB 5 __ 803 (G 1/4") or RB 5 __ 121 G (G 1/2"). Please add two digits for the number of positions required.

Type	Function	Weight
R 5 803 R	End-plate right	0,20 kg
R 5 803 L	End-plate left	0,20 kg
R 5 803	Individual position	0,10 kg

Type	Function	Weight
R 5 121 GR	End-plate right	0,24 kg
R 5 121 GL	End-plate left	0,24 kg
R 5 121	Individual position	0,15 kg

RD 5__ 344/RD 5__ 464



Common connection to port 1 (pressure), 3 and 5 (exhaust).
The individual ports 2 and 4 are also in the manifold plate equipped with push-in fittings.

The following solenoid valves can be assembled to the manifold plate type **RD 5__ 344** (pif 4 mm):

5/2 single sol.	MD 510 304	page 2.5.2.2.3
5/2 double sol.	MD 520 304	page 2.5.2.2.7
5/3-way	MD 53_ 304	page 2.5.3.2.3

Blanking plates are also available type BP 5 304.

The following solenoid valves can be assembled to the manifold plate type **RD 5__ 464** (pif 6 mm):

5/2 single sol.	MD 510 404	page 2.5.2.2.3
5/2 double sol.	MD 520 404	page 2.5.2.2.7
5/3-way	MD 53_ 404	page 2.5.3.2.3

Blanking plates are also available type BP 5 404.

Please note:
Due to the compact design of the plate if a larger number of valves are to switch at the same time please do not select plates with more than 6 stations.

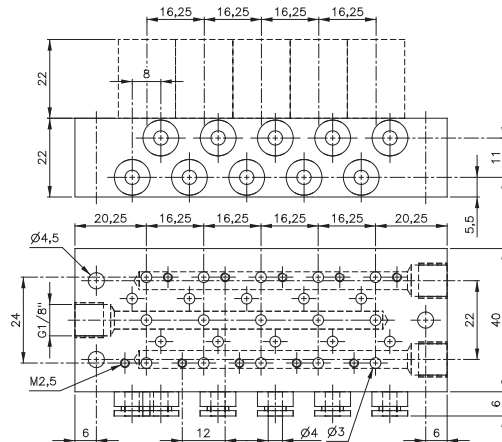

RD 5__ 344 Orifice size: 5 mm

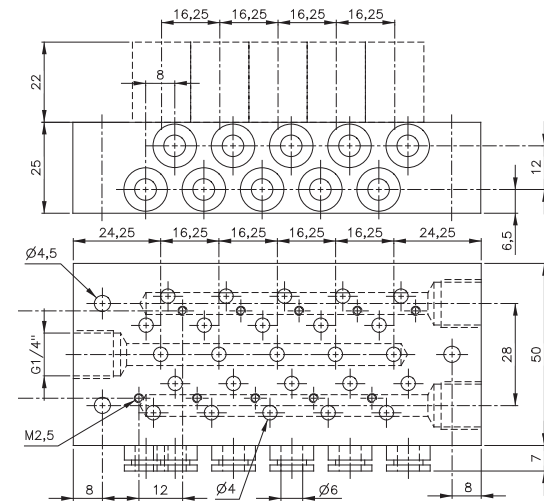

RD 5__ 464 Orifice size: 6 mm

Stations	Type	Weight	Availability	Type	Weight	Availability
2	RD 502 344	0,14 kg	from stock	RD 502 464	0,21 kg	from stock
3	RD 503 344	0,18 kg	from stock	RD 503 464	0,27 kg	from stock
4	RD 504 344	0,22 kg	from stock	RD 504 464	0,33 kg	from stock
5	RD 505 344	0,26 kg	from stock	RD 505 464	0,38 kg	from stock
6	RD 506 344	0,30 kg	from stock	RD 506 464	0,44 kg	from stock
7	RD 507 344	0,34 kg	on request	RD 507 464	0,50 kg	from stock
8	RD 508 344	0,38 kg	from stock	RD 508 464	0,55 kg	from stock
9	RD 509 344	0,42 kg	on request	RD 509 464	0,60 kg	from stock
10	RD 510 344	0,46 kg	from stock	RD 510 464	0,66 kg	from stock
12	RD 512 344	0,54 kg	from stock	RD 512 464	0,77 kg	from stock
14	RD 514 344	0,62 kg	on request	RD 514 464	0,88 kg	on request
16	RD 516 344	0,70 kg	on request	RD 516 464	0,99 kg	on request

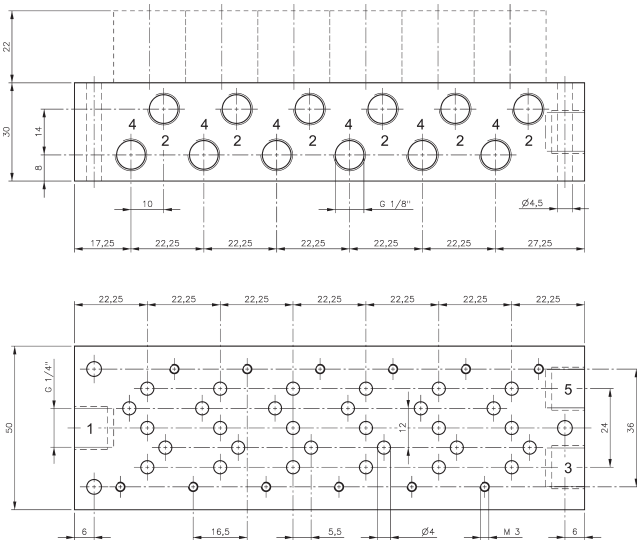

R 5__ 304 Orifice size: 6 mm

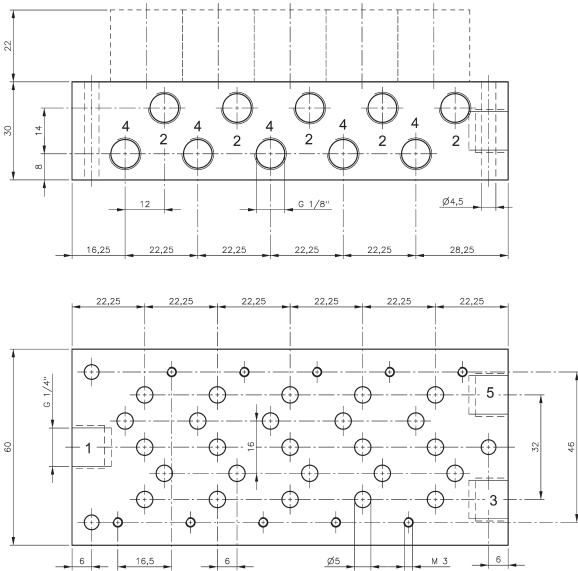

R 5__ 504 Orifice size: 6,6 mm

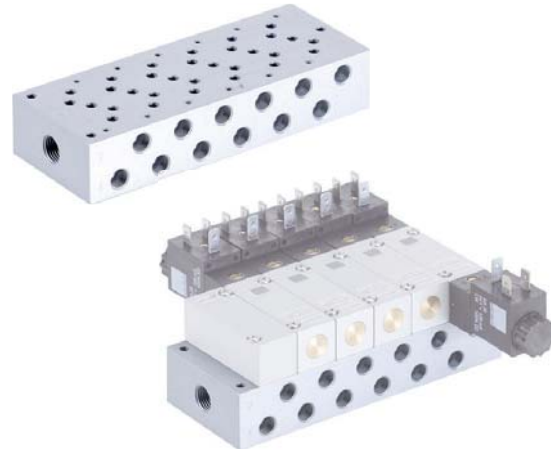

Common connection to port 1 (pressure), 3 (exhaust) and 5 (exhaust). The ports 2 and 4 of the individual valves are also located in the manifold plate.

The following solenoid valves can be assembled to the manifold plate type **R 5__ 304** (G 1/8" orifice 3 mm):

- 5/2 single sol. MH 510 304 page 2.5.2.2.4
- 5/2 double sol. MH 520 304 page 2.5.2.2.8
- 5/3-way MH 53_304 page 2.5.3.2.4

Blanking plates are also available type BPH 5 304.

The following solenoid valves can be assembled to the manifold plate type **R 5__ 504** (G 1/8" orifice 5 mm):

- 5/2 single sol. MH 510 504 page 2.5.2.2.4
- 5/2 double sol. MH 520 504 page 2.5.2.2.8
- 5/3-way MH 53_504 page 2.5.3.2.4

Blanking plates are also available type BP 5 504.

Stations	Type	Weight	Type	Weight
2	R 502 304	0,26 kg	R 502 504	0,30 kg
3	R 503 304	0,34 kg	R 503 504	0,40 kg
4	R 504 304	0,42 kg	R 504 504	0,50 kg
5	R 505 304	0,51 kg	R 505 504	0,60 kg
6	R 506 304	0,59 kg	R 506 504	0,70 kg
8	R 508 304	0,76 kg	R 508 504	0,89 kg
10	R 510 304	0,93 kg	R 510 504	1,08 kg
12	R 512 304	1,11 kg	R 512 504	1,29 kg

R 5__704/R 5__784

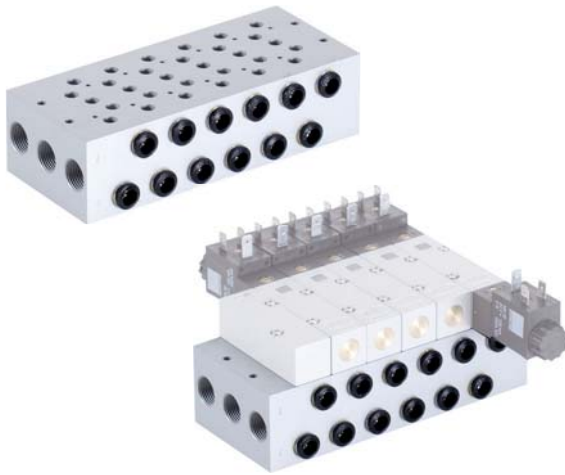

Common connection to port 1 (pressure), 3 (exhaust) and 5 (exhaust). The ports 2 and 4 of the individual valves are also located in the manifold plate.

The following valves can be assembled to the manifold plate type **R 5__704** (G 1/4") and **R 5__784** (pif 8 mm):

- | | | |
|---------|------------|----------------|
| 5/2-way | MH 510 704 | page 2.5.2.2.4 |
| 5/2-way | MH 520 704 | page 2.5.2.2.8 |
| 5/3-way | MH 53_704 | page 2.5.3.2.4 |

Blanking plates are also available type BP 5 704.

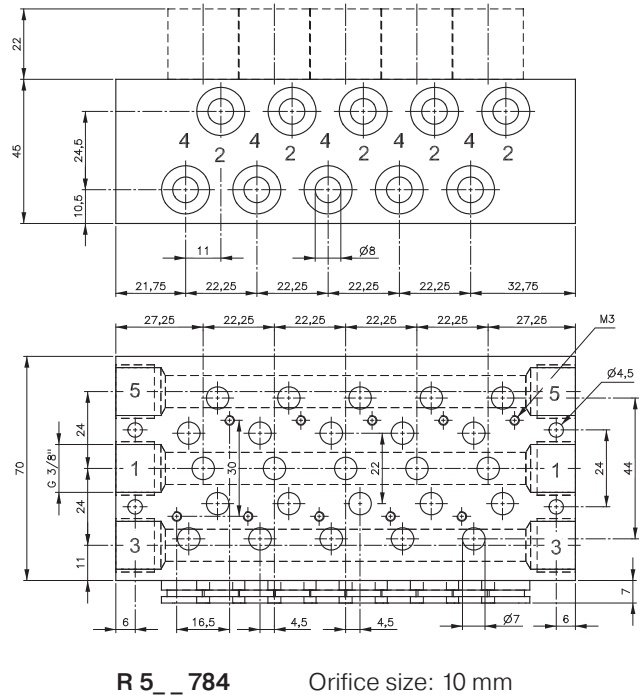
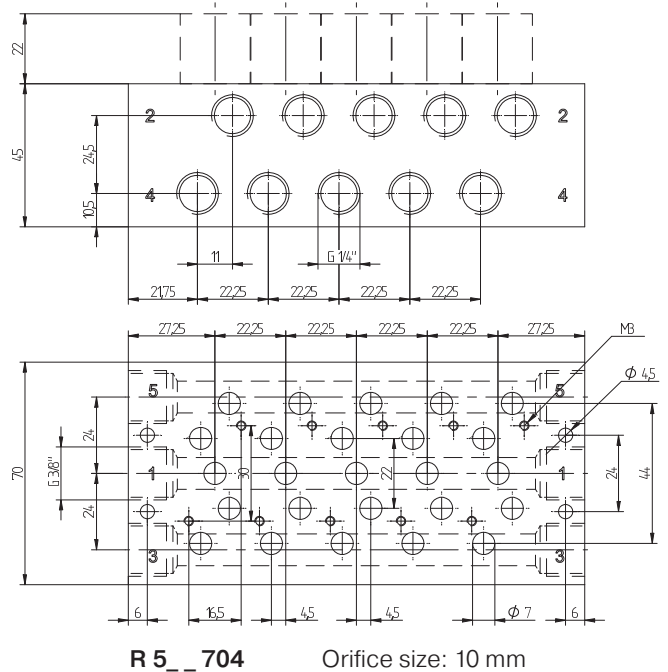

Stations	Type	Weight	Type	Weight
2	R 502 704	0,54 kg	R 502 784	0,54 kg
3	R 503 704	0,72 kg	R 503 784	0,72 kg
4	R 504 704	0,90 kg	R 504 784	0,90 kg
5	R 505 704	1,10 kg	R 505 784	1,10 kg
6	R 506 704	1,25 kg	R 506 784	1,25 kg
8	R 508 704	1,60 kg	R 508 784	1,60 kg
10	R 510 704	1,95 kg	R 510 784	1,95 kg
12	R 512 704	2,32 kg	R 512 784	2,32 kg

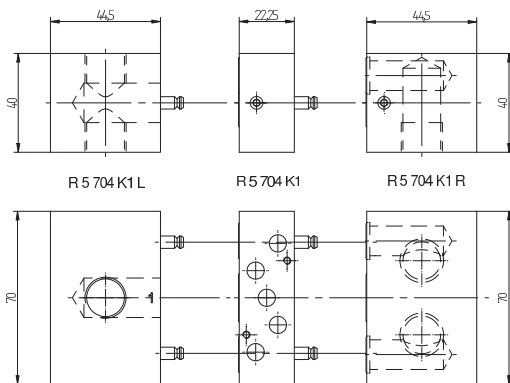

Parts of modular manifold RB 5__ 704 K1

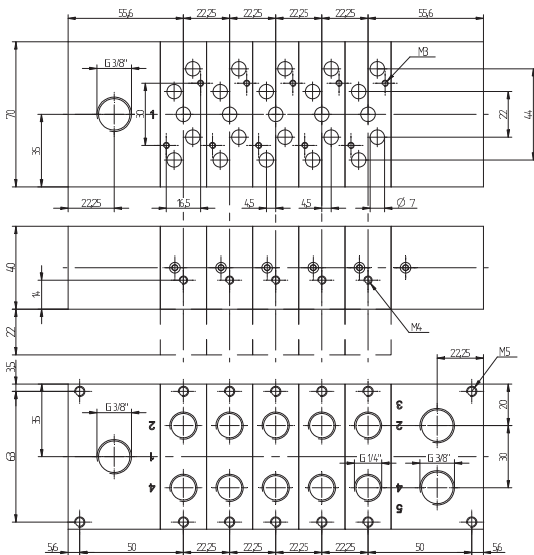

RB 5__ 704 K1

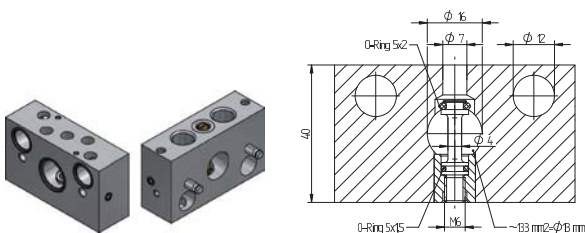

Individual valve isolation (R 5 704 K1 D1)



Bottom side

Modular manifold system with all ports on the bottom. Plates are designed for assemblage in control cabinets.

Common connection to port 1 (pressure), 3 (exhaust) and 5 (exhaust). The ports 2 and 4 of the individual valves are also located in the manifold plate. The system can be build up and taken apart by just operating two hexagon socket screws. Additional stations can be added at any position and any time.

The following valves can be assembled to the system

RB 5__ 704 K1:

5/2 single solenoid	MH 510 704	page 2.5.2.2.4
5/2 double solenoid	MH 520 704	page 2.5.2.2.8
5/3 solenoid	MH 53_704	page 2.5.3.2.4

3/2-way functions by closing either port 2 or 4.

The system consists of:

End-plate right	type R 5 704 K1 R
End-plate left	type R 5 704 K1 L
Individual position	type R 5 704 K1

Blanking plates are also available type BP 5 704.

Please note:

End-plates are not offering an individual valve-position.

The plates can also be ordered assembled by the manufacturer. In this case order **RB 5__ 704 K1**. Please add two digits for the number of positions required.

In case the customer wants to have the FRL inside the box, the endplate left offers as second supply port that faces inside the box. One of the two has to be closed with a G 3/8" plug.

The individual plates are also available with individual valve isolation type R 5 704 K1 D1. In certain industries the user appreciates, if he can take away air pressure at any valve on the plate individually. Valves can easily be exchanged by closing the plug in port 1 without interruption of the air-supply of the other valves.

Wider elements for usage with wider coils (e.g. ATEX-approved versions) are available on request.

Type	Function	Weight
R 5 704 K1 R	End-plate right	0,13 kg
R 5 704 K1 L	End-plate left	0,12 kg
R 5 704 K1	Individual position	0,09 kg
R 5 704 K1 D1	Individual position, with individual valve isolation	0,09 kg

RB 5__ 104 K1



Bottom side

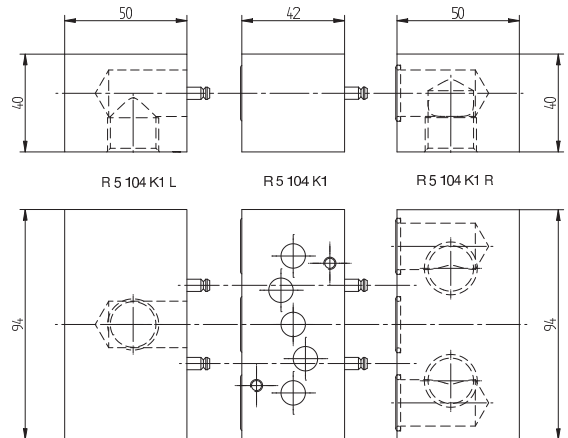

Parts of modular manifold RB 5__ 104 K1

Modular manifold system with all ports on the bottom. Plates are designed for assemblage in control cabinets.

Common connection to port 1 (pressure), 3 (exhaust) and 5 (exhaust). The ports 2 and 4 of the individual valves are also located in the manifold plate. The system can be build up and taken apart by just operating two hexagon socket screws.

Additional stations can be added at any position and any time.

The following valves can be assembled to the system

RB 5__ 104 K1:

5/2 single solenoid	MH 510 104	page 2.5.2.2.4
5/2 double solenoid	MH 520 104	page 2.5.2.2.8
5/3 solenoid	MH 53__ 104	page 2.5.3.2.4

The system consists of:

End-plate right	type R 5 104 K1 R
End-plate left	type R 5 104 K1 L
Individual position	type R 5 104 K1

Please note:
End-plates are not offering an individual valve-position.

The plates can also be ordered assembled by the manufacturer. In this case order **RB 5__ 104 K1**. Please add two digits for the number of positions required.

The individual plates are also available with individual valve isolation type R 5 104 K1 D1. In certain industries the user appreciates, if he can take away air pressure at any valve on the plate individually. Valves can easily be exchanged by closing the plug in port 1 without interruption of the air-supply of the other valves.

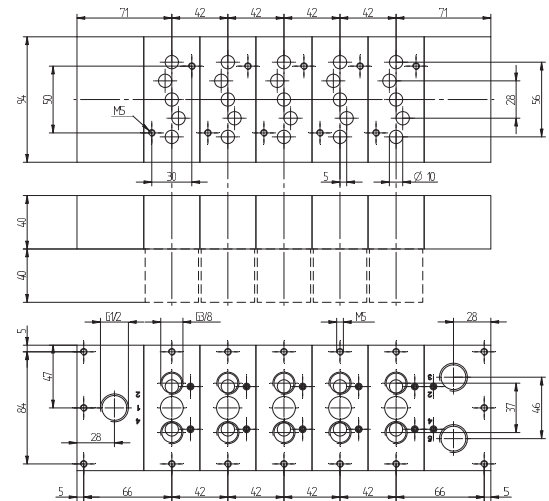

RB 5__ 104 K1

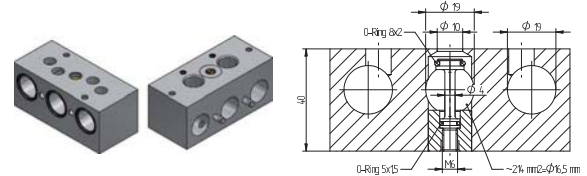

Individual valve isolation (R 5 104 K1 D1)

Type	Function	Weight
R 5 104 K1 R	End-plate right	0,45 kg
R 5 104 K1 L	End-plate left	0,50 kg
R 5 104 K1	Individual position	0,32 kg
R 5 104 K1 D1	Individual position, with individual valve isolation	0,32 kg



Bottom side



Bottom side

Hafner is offering a range of products designed to make the assemblage of manifolds and valve terminals inside a control cabinet as easy as possible. No tubing needs to stay inside the box!

- **Series 704 K1** with a maximum air-flow of 1.250 l/min
Further information on page 2.7.2.9 and 2.8.3.8
- **Series 104 K1** with a maximum air-flow of 2.250 l/min
Further information on page 2.7.2.10

The Hafner system offers distinct advantages:

- Less effort to assemble = significant time-savings
- No bulk-head fittings required
- Less installation material = significant material savings
- No hoses inside the box
- Less risk of leakage inside the box, significant air savings



Available as a special feature:

Manifolds with **individual valve isolation screw** (suffix D1 to type-number). Valves can easily be exchanged by closing the plug in port 1 without interruption of the air-supply of the other valves.



Image source: Voith GmbH

Application examples:

Control cabinet with 8 x 5/2-way single solenoid valves with 7 mm orifice, assembled on a valve terminal. Manifold is having the individual valve isolation feature.



Image source: Voith GmbH

Air distributor cabinet with pressure regulator, main shut-off valve and 12 outlets.

DIN-rail mounting clips



For assembling valve-terminals,
please send us your inquiry.



Mounting accessory to assemble and dismantle manifold plates to and from 35 mm wide DIN-rails. The mounting accessory is generally to be assembled on the back of the manifold plate by the manufacturer. Self-assembly is also possible, assembly drawings can be made available.



All the manifold plates offered by Hafner-Pneumatik can be equipped with the DIN-rail mounting clips.

Modular manifolds are generally equipped with threads for assembling DIN-rails.

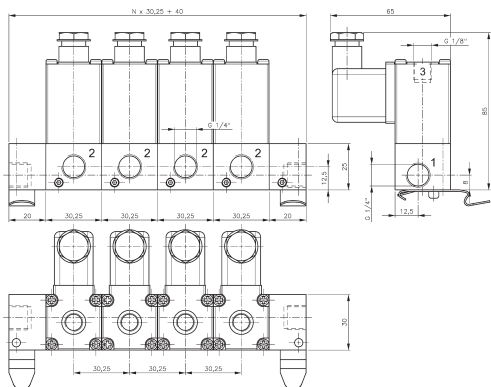

Also individual valves such as the **MH 311 015 DIN** can be equipped with DIN-rail mounting clips.

