

2.14

Products for Explosion Hazardous Environment



General information on Hafner products for explosion hazardous environment

Example marking of an electric product for explosion hazardous environment:

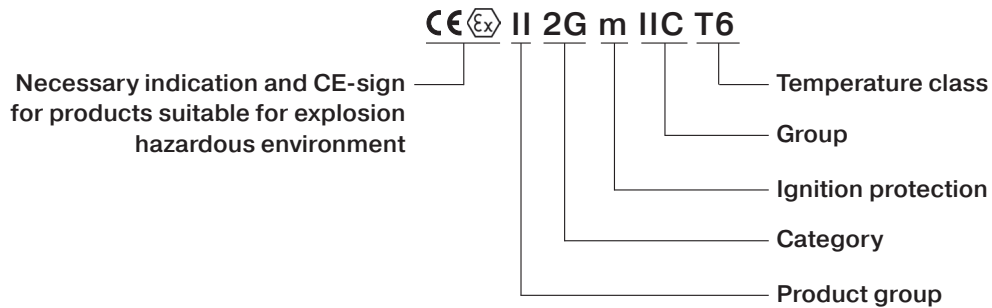

Product group:

Product group I

Products from product group I are distinguished between M1 and M2. Both are suitable for mining applications. They are not in our focus as Hafner does not offer suitable equipment.

Product group II

All other products for explosion hazardous environment are in this group.

Category:

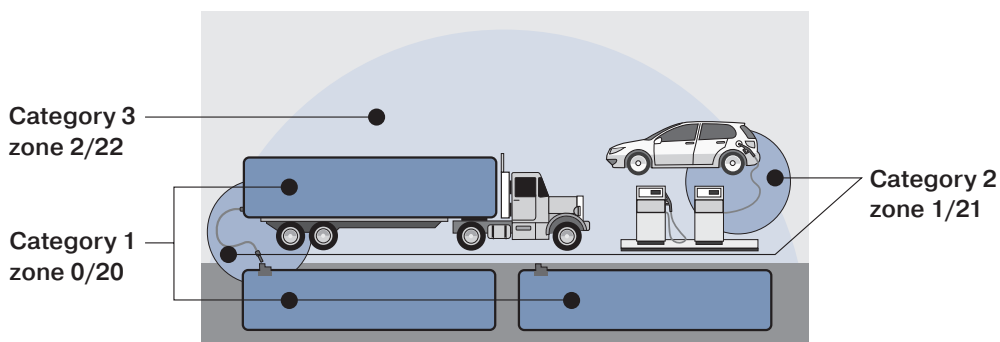

Category I

An area in which an explosive mixture is continuously present or present for long periods > 1000 hours/year.

Category II

An area in which an explosive mixture is occasionally present 10 – 1000 hours/year.

Category III

An area in which an explosive mixture is not likely to occur in normal operation and if it occurs it will exist only for a short time < 10 hours/year.

General information on Hafner products for explosion hazardous environment

| | Zones for Gases | Zones for Dust |
|------------|---|---|
| Category 1 | <p>Zone 0 Area in which an explosion hazardous atmosphere consisting of air and inflammable gases, vapors or fog is present constantly or over a longer period of time. > 1000 hours/year</p> | <p>Zone 20 Area in which an explosion hazardous atmosphere consisting of a dust-cloud or a mix of air and dust is present constantly or over a longer period of time. > 1000 hours/year</p> |
| Category 2 | <p>Zone 1 Area in which there is a probability that under normal conditions an explosion hazardous atmosphere consisting of air and inflammable gases, vapors or fog can be present. 10 – 1000 hours/year</p> | <p>Zone 21 Area in which there is a probability that under normal conditions an explosion hazardous atmosphere consisting of a dust-cloud or a mix of air and dust can be present. 10 – 1000 hours/year</p> |
| Category 3 | <p>Zone 2 Area in which once and a while an explosion hazardous atmosphere consisting of air and inflammable gases, steam or vapors can be present. < 10 hours/year</p> | <p>Zone 22 Area in which once and a while an explosion hazardous atmosphere consisting of a dust-cloud or a mix of air and dust can be present. < 10 hours/year</p> |

Covered by the Hafner product range

Ignition protection (examples):

| | General definition: | For Hafner products: |
|----|-------------------------------|--|
| c | Constructional safety | general protection for mechanical ATEX |
| i | Intrinsic safety | called ia for solenoids |
| na | Non sparking | |
| m | Encapsulation | with cable |
| me | Encapsulation enhanced safety | called Ex emb with junction box |
| d | Flameproof enclosure | with junction box |
| dm | Flameproof encapsulation | with junction box |

Group:

For various substances the explosive and spark ignition capability of a potentially explosive mixture are characteristics. Vapors and gases are classified in groups. The criteria for the subdivision are the maximum experimental safe gap and the minimum ignition current. Those are determined under precisely defined test conditions for various vapors and gases. Please refer to IEC60079-1A and IEC60079-3.

The hazard increases from group IIA to IIC, therefore the requirements applicable to electrical equipment become more strict. Consequently products classified IIC can also be used in IIB and IIA.

Temperatur classes:

| Temperature class | Max. permitted surface temperature of equipment |
|-------------------|---|
| T1 | 450°C |
| T2 | 300°C |
| T3 | 200°C |
| T4 | 135°C |
| T5 | 100°C |
| T6 | 85°C |

T6 contains all other temperature classes

Non-electric valves for explosion hazardous environment

The following **manually and mechanically actuated valves** are available for the use in explosion hazardous environment in zones 1, 2, 21, 22 gas and dust:

| Type | Function | Port size | Further inform. on valve on page | |
|---------------|-----------------------------|-----------|----------------------------------|--|
| | | | | |
| BV 311 301 EX | 3/2-way, stem actuated | G 1/8" | 2.1.1.4 | |
| BV 511 301 EX | 5/2-way, stem actuated | G 1/8" | 2.1.2.2 | |
| BA 311 301 EX | 3/2-way, for panel mounting | G 1/8" | 2.2.1 | |
| BA 511 301 EX | 5/2-way, for panel mounting | G 1/8" | 2.2.2 | |
| BA 22_ | Actuator elements | | 2.2.3 | |



The products are marked:

II2G/D c T6 -10° C ≤ Ta ≤ 50° C

Delivery contains a manual as well as a declaration of conformity.

A declaration of the manufacturer that the actuation elements BA 22_ do not require a certification can be supplied on request. For the use in dust atmosphere we recommend the use of a dust protection cap.

The following **pneumatically actuated valves** are available for the use in explosion hazardous environment in zone zone 1, 2, 21, 22 gas and dust:

| Type | Function | Port size | Further information on valve on page | | |
|--------------|-----------------------------|------------------|--------------------------------------|-----------|---------------|
| | | | Aluminum | Low Temp. | Stainl. Steel |
| P 310 502 EX | 3/2-way, single sol. | G 1/8" | 2.4.1.1 | | |
| P 310 501 EX | 3/2-way, single sol. | G 1/8" | 2.4.1.2 | 2.11.4.1 | |
| P 310 701 EX | 3/2-way, single sol. | G 1/4" -1/4" NPT | 2.4.1.2 | 2.11.4.1 | 2.12.3.1 |
| P 310 801 EX | 3/2-way, single sol. | G 1/4" | 2.4.1.2 | | |
| P 310 101 EX | 3/2-way, single sol. | G 3/8" | 2.4.1.3 | | |
| P 310 121 EX | 3/2-way, single sol. | G 1/2" -1/2" NPT | 2.4.1.3 | 2.11.4.2 | 2.12.3.1 |
| P 320 502 EX | 3/2-way, double sol. | G 1/8" | 2.4.1.5 | | |
| P 320 501 EX | 3/2-way, double sol. | G 1/8" | 2.4.1.6 | 2.11.4.1 | |
| P 320 701 EX | 3/2-way, double sol. | G 1/4" -1/4" NPT | 2.4.1.6 | 2.11.4.1 | |
| P 320 801 EX | 3/2-way, double sol. | G 1/4" | 2.4.1.6 | | |
| P 320 101 EX | 3/2-way, double sol. | G 3/8" | 2.4.1.7 | | |
| P 320 121 EX | 3/2-way, double sol. | G 1/2" -1/2" NPT | 2.4.1.7 | | |
| P 510 502 EX | 5/2-way, single sol. | G 1/8" | 2.4.2.1 | | |
| P 510 501 EX | 5/2-way, single sol. | G 1/8" | 2.4.2.2 | 2.11.4.3 | |
| P 510 701 EX | 5/2-way, single sol. | G 1/4" -1/4" NPT | 2.4.2.2 | 2.11.4.3 | 2.12.3.2 |
| P 510 801 EX | 5/2-way, single sol. | G 1/4" | 2.4.2.2 | | |
| P 510 101 EX | 5/2-way, single sol. | G 3/8" | 2.4.2.3 | | |
| P 510 121 EX | 5/2-way, single sol. | G 1/2" -1/2" NPT | 2.4.2.3 | 2.11.4.3 | 2.12.3.2 |
| P 520 502 EX | 5/2-way, double sol. | G 1/8" | 2.4.2.5 | | |
| P 520 501 EX | 5/2-way, double sol. | G 1/8" | 2.4.2.6 | 2.11.4.4 | |
| P 520 701 EX | 5/2-way, double sol. | G 1/4" -1/4" NPT | 2.4.2.6 | 2.11.4.4 | 2.12.3.3 |
| P 520 801 EX | 5/2-way, double sol. | G 1/4" | 2.4.2.6 | | |
| P 520 101 EX | 5/2-way, double sol. | G 3/8" | 2.4.2.7 | | |
| P 520 121 EX | 5/2-way, double sol. | G 1/2" -1/2" NPT | 2.4.2.7 | | 2.12.3.3 |
| P 531 501 EX | 5/3-way, centre closed | G 1/8" | 2.4.3.1 | 2.11.4.4 | |
| P 531 701 EX | 5/3-way, centre closed | G 1/4" -1/4" NPT | 2.4.3.1 | 2.11.4.4 | 2.12.3.3 |
| P 531 801 EX | 5/3-way, centre closed | G 1/4" | 2.4.3.1 | | |
| P 531 101 EX | 5/3-way, centre closed | G 3/8" | 2.4.3.2 | | |
| P 531 121 EX | 5/3-way, centre closed | G 1/2" -1/2" NPT | 2.4.3.2 | | 2.12.3.3 |
| P 532 501 EX | 5/3-way, centre exhausted | G 1/8" | 2.4.3.1 | 2.11.4.4 | |
| P 532 701 EX | 5/3-way, centre exhausted | G 1/4" -1/4" NPT | 2.4.3.1 | 2.11.4.4 | 2.12.3.3 |
| P 532 801 EX | 5/3-way, centre exhausted | G 1/4" | 2.4.3.1 | | |
| P 532 101 EX | 5/3-way, centre exhausted | G 3/8" | 2.4.3.2 | | |
| P 532 121 EX | 5/3-way, centre exhausted | G 1/2" -1/2" NPT | 2.4.3.2 | | 2.12.3.3 |
| P 533 501 EX | 5/3-way, centre pressurised | G 1/8" | 2.4.3.1 | 2.11.4.4 | |
| P 533 701 EX | 5/3-way, centre pressurised | G 1/4" -1/4" NPT | 2.4.3.1 | 2.11.4.4 | 2.12.3.3 |
| P 533 801 EX | 5/3-way, centre pressurised | G 1/4" | 2.4.3.1 | | |
| P 533 101 EX | 5/3-way, centre pressurised | G 3/8" | 2.4.3.2 | | |
| P 533 121 EX | 5/3-way, centre pressurised | G 1/2" -1/2" NPT | 2.4.3.2 | | 2.12.3.3 |

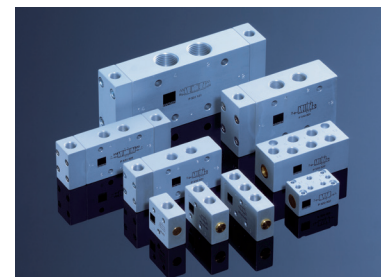

The products are marked:

II2G/D c T6 -10° C ≤ Ta ≤ 50° C







Delivery contains a manual as well as a declaration of conformity.





ATEX-certified pneumatically actuated valves for low-temperature applications as well as stainless steel products are available on request.

Solenoid valves for explosion hazardous environment

General information – overview

Our customers have the choice between numerous solenoid systems of different ignition protection types. Those can be combined with valves made from aluminum or stainless steel designed for different temperature classes.

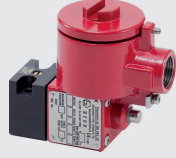
| Valve | Temp.-range | Ignition protection type | | |
|---|---------------------|---|--|---|
| | | Ex na (non-sparking) | Ex ia (intrinsically safe) | Ex m (encapsulation) |
|  | |  |  |  |
| Aluminum | -10°C ... + 50°C | ✓ | ✓ | ✓ |
| Stainless steel  | -10°C ... + 50°C | ✓ | ✓ | ✓ |
| Aluminum | -40°C ... + 50°C ❄️ | n.a. | ✓ | n.a. |
| Stainless steel  | -40°C ... + 50°C ❄️ | n.a. | ✓ | n.a. |
| Zone | | 2, 22 | 1, 21, 2, 22 | 1, 21, 2, 22 |
| IEC-Ex rated | | | ✓ | ✓ |
| Reference: | | 2.14.3.4.3 | 2.14.3.3.5 | 2.14.3.2.4 |

| Valve | Temp.-range | Ignition protection class | | |
|---|---------------------|---|--|---|
| | | Ex e mb (encapsulation with junction box) | Ex dm (encapsulation with junction box) | Ex d (flameproof with junction box) |
|  | |  |  |  |
| Aluminum | -10°C ... + 50°C | ✓ | ✓ | ✓ |
| Stainless steel  | -10°C ... + 50°C | ✓ | ✓ | ✓ |
| Aluminum | -40°C ... + 50°C ❄️ | ✓ | ✓ | ✓ |
| Stainless steel  | -40°C ... + 50°C ❄️ | ✓ | ✓ | ✓ |
| Zone | | 1, 21, 2, 22 | 1, 21, 2, 22 | 1, 21, 2, 22 |
| IEC-Ex rated | | ✓ | | ✓ |
| Reference: | | 2.14.3.5.4 | 2.14.3.7.5 | 2.14.3.6.5 |

ATEX-approved valves – Ex m – standard temperature range – aluminum



Material: Aluminum, anodized
 Zone: 1, 2, 21, 22
 Temperature range: -10°C ... +50°C
 Ignition protection type: Ex m (encapsulation)
 Temperature class: T4

Marking on valve  II2G/D c T4 -10°C ≤ Ta ≤ 50°C

A low temperature version for -20°C ... +50°C is also available on request. Please note that the system is restricted by the minimum ambient temperature for the coil of -20°C.

The following solenoid valves are available:

| Type | Function | Port size | Installation | Further inform. on valve |
|--------------------|---------------------------|-------------------|--------------|--------------------------|
| MH 210 501 Ex m | 2/2-way, single sol. | G 1/8" | in-line | 2.5.1.1.13 |
| MH 210 701 Ex m | 2/2-way, single sol. | G 1/4" | in-line | 2.5.1.1.13 |
| MH 311 012 Ex m | 3/2-way direct acting | M5 | in-line | 2.5.1.1.2 |
| MH 311 015 Ex m | 3/2-way direct acting | G 1/8" | in-line | 2.5.1.1.2 |
| MH 311 013 Ex m | 3/2-way direct acting | G 1/8" | banjo screw | 2.5.1.1.8 |
| MH 311 017 Ex m | 3/2-way direct acting | G 1/4" | banjo screw | 2.5.1.1.8 |
| MH 312 Ex m | 3/2-way direct acting | M5 | manifold | 2.5.1.2.2 |
| MH 315 Ex m | 3/2-way direct acting | G 1/8" | manifold | 2.5.1.2.2 |
| MH 310 501 Ex m | 3/2-way, single sol. | G 1/8" | in-line | 2.5.1.1.14 |
| MOH 310 501 Ex m | 3/2-way, n.o. single sol. | G 1/8" | in-line | 2.5.1.1.14 |
| MH 310 701 Ex m | 3/2-way, single sol. | G 1/4" | in-line | 2.5.1.1.14 |
| MOH 310 701 Ex m | 3/2-way, n.o. single sol. | G 1/4" | in-line | 2.5.1.1.14 |
| MH 310 801 Ex m | 3/2-way, single sol. | G 1/4" | in-line | 2.5.1.1.14 |
| MOH 310 801 Ex m | 3/2-way, n.o. single sol. | G 1/4" | in-line | 2.5.1.1.14 |
| MH 310 101 Ex m | 3/2-way, single sol. | G 3/8" | in-line | 2.5.1.1.15 |
| MOH 310 101 Ex m | 3/2-way, n.o. single sol. | G 3/8" | in-line | 2.5.1.1.15 |
| MH 310 121 Ex m | 3/2-way, single sol. | G 1/2" - 1/2" NPT | in-line | 2.5.1.1.15 |
| MOH 310 121 Ex m | 3/2-way, n.o. single sol. | G 1/2" - 1/2" NPT | in-line | 2.5.1.1.15 |
| MH 310 501 G Ex m | 3/2-way, single sol. | G 1/8" | dual use* | 2.5.1.1.16 |
| MOH 310 501 G Ex m | 3/2-way, n.o. single sol. | G 1/8" | dual use* | 2.5.1.1.16 |
| MH 310 701 G Ex m | 3/2-way, single sol. | G 1/4" - 1/4" NPT | dual use* | 2.5.1.1.16 |
| MOH 310 701 G Ex m | 3/2-way, n.o. single sol. | G 1/4" - 1/4" NPT | dual use* | 2.5.1.1.16 |
| MH 310 101 G Ex m | 3/2-way, single sol. | G 3/8" | dual use* | 2.5.1.1.17 |
| MOH 310 101 G Ex m | 3/2-way, n.o. single sol. | G 3/8" | dual use* | 2.5.1.1.17 |
| MH 310 121 G Ex m | 3/2-way, single sol. | G 1/2" | dual use* | 2.5.1.1.17 |
| MOH 310 121 G Ex m | 3/2-way, n.o. single sol. | G 1/2" | dual use* | 2.5.1.1.17 |
| MH 320 501 Ex m | 3/2-way, double sol. | G 1/8" | in-line | 2.5.1.1.18 |
| MH 320 701 Ex m | 3/2-way, double sol. | G 1/4" | in-line | 2.5.1.1.18 |
| MH 320 801 Ex m | 3/2-way, double sol. | G 1/4" | in-line | 2.5.1.1.18 |
| MH 320 101 Ex m | 3/2-way, double sol. | G 3/8" | in-line | 2.5.1.1.19 |
| MH 320 121 Ex m | 3/2-way, double sol. | G 1/2" | in-line | 2.5.1.1.19 |
| MH 320 501 G Ex m | 3/2-way, double sol. | G 1/8" | dual use* | 2.5.1.1.20 |
| MH 320 701 G Ex m | 3/2-way, double sol. | G 1/4" | dual use* | 2.5.1.1.20 |
| MH 320 101 G Ex m | 3/2-way, double sol. | G 3/8" | dual use* | 2.5.1.1.20 |
| MH 320 121 G Ex m | 3/2-way, double sol. | G 1/2" | dual use* | 2.5.1.1.20 |
| MH 510 501 Ex m | 5/2-way, single sol. | G 1/8" | in-line | 2.5.2.1.3 |
| MH 510 701 Ex m | 5/2-way, single sol. | G 1/4" | in-line | 2.5.2.1.3 |
| MH 510 801 Ex m | 5/2-way, single sol. | G 1/4" | in-line | 2.5.2.1.3 |
| MH 510 101 Ex m | 5/2-way, single sol. | G 3/8" | in-line | 2.5.2.1.4 |
| MH 510 121 Ex m | 5/2-way, single sol. | G 1/2" - 1/2" NPT | in-line | 2.5.2.1.4 |
| MH 510 501 G Ex m | 5/2-way, single sol. | G 1/8" | dual use* | 2.5.2.1.5 |
| MH 510 701 G Ex m | 5/2-way, single sol. | G 1/4" - 1/4" NPT | dual use* | 2.5.2.1.5 |
| MH 510 101 G Ex m | 5/2-way, single sol. | G 3/8" | dual use* | 2.5.2.1.6 |
| MH 510 121 G Ex m | 5/2-way, single sol. | G 1/2" | dual use* | 2.5.2.1.6 |

| Type | Function | Port size | Installation | Further inform. on valve |
|-------------------|-------------------------|-------------------|--------------|--------------------------|
| MH 510 504 Ex m | 5/2-way, single sol. | 5 mm orifice | manifold** | 2.5.2.2.4 |
| MH 510 704 Ex m | 5/2-way, single sol. | 7 mm orifice | manifold** | 2.5.2.2.4 |
| MH 520 501 Ex m | 5/2-way, double sol. | G 1/8" | in-line | 2.5.2.1.9 |
| MH 520 701 Ex m | 5/2-way, double sol. | G 1/4" | in-line | 2.5.2.1.9 |
| MH 520 801 Ex m | 5/2-way, double sol. | G 1/4" | in-line | 2.5.2.1.9 |
| MH 520 101 Ex m | 5/2-way, double sol. | G 3/8" | in-line | 2.5.2.1.10 |
| MH 520 121 Ex m | 5/2-way, double sol. | G 1/2" - 1/2" NPT | in-line | 2.5.2.1.10 |
| MH 520 501 G Ex m | 5/2-way, double sol. | G 1/8" | dual use* | 2.5.2.1.11 |
| MH 520 701 G Ex m | 5/2-way, double sol. | G 1/4" - 1/4" NPT | dual use* | 2.5.2.1.11 |
| MH 520 101 G Ex m | 5/2-way, double sol. | G 3/8" | dual use* | 2.5.2.1.12 |
| MH 520 121 G Ex m | 5/2-way, double sol. | G 1/2" | dual use* | 2.5.2.1.12 |
| MH 520 504 Ex m | 5/2-way, double sol. | 5 mm orifice | manifold** | 2.5.2.2.8 |
| MH 520 704 Ex m | 5/2-way, double sol. | 7 mm orifice | manifold** | 2.5.2.2.8 |
| MH 53_ 501 Ex m | 5/3-way, diff. versions | G 1/8" | in-line | 2.5.3.1.2 |
| MH 53_ 701 Ex m | 5/3-way, diff. versions | G 1/4" | in-line | 2.5.3.1.2 |
| MH 53_ 801 Ex m | 5/3-way, diff. versions | G 1/4" | in-line | 2.5.3.1.2 |
| MH 53_ 101 Ex m | 5/3-way, diff. versions | G 3/8" | in-line | 2.5.3.1.3 |
| MH 53_ 121 Ex m | 5/3-way, diff. versions | G 1/2" - 1/2" NPT | in-line | 2.5.3.1.3 |
| MH 53_ 501 G Ex m | 5/3-way, diff. versions | G 1/8" | dual use* | 2.5.3.1.4 |
| MH 53_ 701 G Ex m | 5/3-way, diff.versions | G 1/4" - 1/4" NPT | dual use* | 2.5.3.1.4 |
| MH 53_ 101 G Ex m | 5/3-way, diff. versions | G 3/8" | dual use* | 2.5.3.1.5 |
| MH 53_ 121 G Ex m | 5/3-way, diff. versions | G 1/2" | dual use* | 2.5.3.1.5 |
| MH 53_ 504 Ex m | 5/3-way, diff. versions | 5 mm orifice | manifold** | 2.5.3.2.4 |
| MH 53_ 704 Ex m | 5/3-way, diff. versions | 7 mm orifice | manifold** | 2.5.3.2.4 |

Valves with interface according to NAMUR-standard

| | | | | |
|------------------|-------------------------|-------------------|------------|-----------|
| MNH 350 701 Ex m | 3/2-way & 5/2-way | G 1/4" - 1/4" NPT | 1/4" NAMUR | 2.9.1.3 |
| MNH 310 701 Ex m | 3/2-way, single sol. | G 1/4" - 1/4" NPT | 1/4" NAMUR | 2.9.1.1.1 |
| MNH 310 711 Ex m | 3/2-way, single sol. | G 1/4" | 1/4" NAMUR | 2.9.1.1.1 |
| MNH 310 121 Ex m | 3/2-way, single sol. | G 1/2" - 1/2" NPT | 1/2" NAMUR | 2.9.1.1.2 |
| MNH 510 701 Ex m | 5/2-way, single sol. | G 1/4" - 1/4" NPT | 1/4" NAMUR | 2.9.1.2.1 |
| MNH 510 711 Ex m | 5/2-way, single sol. | G 1/4" | 1/4" NAMUR | 2.9.1.2.1 |
| MNH 510 121 Ex m | 5/2-way, single sol. | G 1/2" - 1/2" NPT | 1/2" NAMUR | 2.9.1.2.2 |
| MNH 520 701 Ex m | 5/2-way, double sol. | G 1/4" - 1/4" NPT | 1/4" NAMUR | 2.9.1.2.3 |
| MNH 520 121 Ex m | 5/2-way, double sol. | G 1/2" - 1/2" NPT | 1/2" NAMUR | 2.9.1.2.3 |
| MNH 53_ 701 Ex m | 5/3-way, diff. versions | G 1/4" - 1/4" NPT | 1/4" NAMUR | 2.9.1.4 |
| MNH 53_ 121 Ex m | 5/3-way, diff. versions | G 1/2" - 1/2" NPT | 1/2" NAMUR | 2.9.1.4 |

* dual use valves can either be used in-line or on a manifold plate.
 ** all ports in plate



Solenoids are described on page 2.14.3.2.4.

Delivery contains valve with the appropriate operator system, coil, manual and declaration of conformity.

ATEX-approved valves – Ex m – standard temperature range – stainless steel



Material: Stainless steel, 316L 
 Zone: 1, 2, 21, 22
 Temperature range: -10°C ... +50°C
 Ignition protection type: Ex m (encapsulation)
 Temperature class: T4

Marking on valve   II2G/D c T4 -10°C ≤ Ta ≤ 50°C

A low temperature version for -20°C ... +50°C is also available on request. Please note that the system is restricted by the minimum applicable temperature of the coil of -20°C.

The following **solenoid valves** are available:

| Type | Function | Port size | Installation | Further information on valve on page |
|----------------------|-----------------------------|-------------------|--------------|--------------------------------------|
| MH 311 015 VES Ex m | 3/2-way direct acting | G 1/8" | in-line | 2.12.4.1 |
| MH 310 701 VES Ex m | 3/2-way, single sol. | G 1/4" - 1/4" NPT | in-line | 2.12.4.2 |
| MOH 310 701 VES Ex m | 3/2-way, n.o. single sol. | G 1/4" - 1/4" NPT | in-line | 2.12.4.2 |
| MH 310 121 VES Ex m | 3/2-way, single sol. | G 1/2" - 1/2" NPT | in-line | 2.12.4.3 |
| MH 320 121 VES Ex m | 3/2-way, double sol. | G 1/2" | in-line | 2.12.4.3 |
| MH 510 701 VES Ex m | 5/2-way, single sol. | G 1/4" - 1/4" NPT | in-line | 2.12.4.4 |
| MH 510 121 VES Ex m | 5/2-way, single sol. | G 1/2" - 1/2" NPT | in-line | 2.12.4.4 |
| MH 520 701 VES Ex m | 5/2-way, double sol. | G 1/4" - 1/4" NPT | in-line | 2.12.4.5 |
| MH 520 121 VES Ex m | 5/2-way, double sol. | G 1/2" - 1/2" NPT | in-line | 2.12.4.5 |
| MH 53_ 701 VES Ex m | 5/3-way, different versions | G 1/4" - 1/4" NPT | in-line | 2.12.4.6 |
| MH 53_ 121 VES Ex m | 5/3-way, different versions | G 1/2" - 1/2" NPT | in-line | 2.12.4.6 |

| Valves with interface according to NAMUR-standard | | | | |
|---|----------------------|-------------------|------------|----------|
| MNH 350 701 VES Ex m | 3/2-way & 5/2-way | G 1/4" - 1/4" NPT | 1/4" NAMUR | 2.12.5.3 |
| MNH 310 701 VES Ex m | 3/2-way, single sol. | G 1/4" - 1/4" NPT | 1/4" NAMUR | 2.12.5.1 |
| MNH 510 701 VES Ex m | 5/2-way, single sol. | G 1/4" - 1/4" NPT | 1/4" NAMUR | 2.12.5.2 |
| MNH 520 701 VES Ex m | 5/2-way, double sol. | G 1/4" - 1/4" NPT | 1/4" NAMUR | 2.12.5.2 |

Solenoids are described on page 2.14.3.2.4.

Delivery contains valve with the appropriate operator system, coil, manual and declaration of conformity.

MA 36 EEx m II T4 CSA FM

CSA / FM approved encapsulated coils for gas and dust explosion-hazardous environment with 60 cm flying leads.

| | |
|--|---|
| Voltage: | Delivery on request: 12VDC, 24VDC, 110VAC, 220VAC, 240VAC |
| Voltage tolerance: | - 10...+ 10% |
| Relative duty cycle: | 100 % |
| Temperature range: | -20°C ... +60°C |
| Protection according to EN 60529: | IP 65 |
| Material solenoid coil: | Thermoplasticpolyester |
| Coil rating according to DIN VDE 0580: | Class H |
| Conduit: | 1/2" NPT |

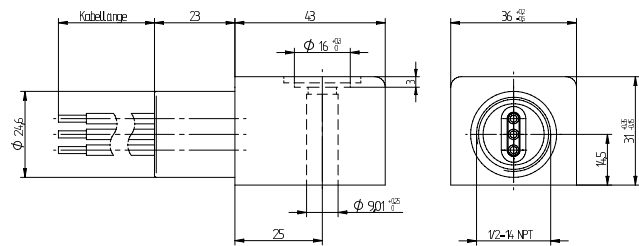

MA 36 EEx m II T4 CSA FM

As the coil is 36 mm wide, a spacer plate called "ZPN 8" has to be used, in case of combination with our NAMUR-valve series 700. If used with NAMUR-valve series 121 a spacer plate called "ZPN 6-5" has to be used. You can find both plates on page 2.10.16.

CSA/FM approval is only valid as long as the associated components are used.

Please note:
The coil is not approved according to ATEX.

Hazardous Locations:

Ex m II T4 and Division 1

Specifications in accordance to CSA certificate:
Class I, Division 1, Groups A, B, C and D; Class II, Groups E, F and G; Class III
Class I, Division 2, Groups A, B, C, D.

Specifications in accordance to FM certificate:
Explosion-proof Class I, Division 1, Groups A, B, C, D, T4, Ta = 60 °C
encapsulation/explosion-proof Class I, Zone 1, AEx m II T4, Ta = 60 °C
dust-ignition-proof for Class II/III, Division 1, Groups E, F and G, T4, Ta = 60 °C
Nonincendive Class I, Division 2, Groups A, B, C, D, T4, Ta = 60 °C
Suitable for Class II, III, Division 2, Groups E, F, G, T4, Ta = 60 °C

The current standards can be found in the certificates.

| Type | Voltage | Operating press. | Power cons. | Temperature class |
|-------------------------------|---------|------------------|-------------|-------------------|
| MA 36 EEx M II T4 CSA FM 12= | 12 V= | max. 10 bar | 4,5 Watt | T4 (135° C) |
| MA 36 EEx M II T4 CSA FM 24= | 24 V= | max. 10 bar | 4,6 Watt | T4 (135° C) |
| MA 36 EEx M II T4 CSA FM 110~ | 110 V~ | max. 10 bar | 6,8 VA | T4 (135° C) |
| MA 36 EEx M II T4 CSA FM 220~ | 220 V~ | max. 10 bar | 7,7 VA | T4 (135° C) |
| MA 36 EEx M II T4 CSA FM 240~ | 240 V~ | max. 10 bar | 7,7 VA | T4 (135° C) |

When this solenoid system is used in combination with „ATEX certified“ mechanical components conforming EN 13463-1:2001 and PrEN 13463-5:2000, the entire valve can be used in explosive hazardous environment zone 1, 2, 21 and 22.

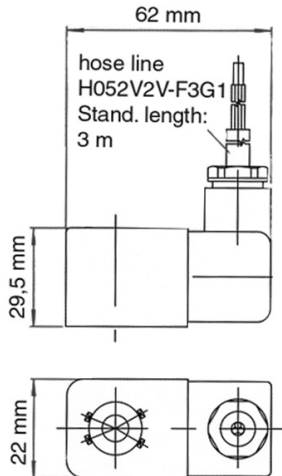

MA 22 EEx m II T4



ATEX approved encapsulated coils for gas and dust explosion-hazardous environment.

System is also IEC-Ex approved.

The standard cable length is 3 meter, others on request.

Voltage tolerance: -10...+10 %

Relative duty cycle: 100 %

Temperature range: -20°...+50° C

Insulation class of insulating materials according to DIN VDE 0580: F

Protection with mounted plug-in connector according to IEC 529: IP 65

Moulding material: Thermoplasticpolyester

Marking on coil:   II 2G Ex mb IIC T4 Gb
II 2D Ex mb tb IIIC T130°C Db

The ATEX approval is only valid as long as the associated components are used.

| Type | Operating press. | Power consumption | Temperature class |
|------------------------|------------------|-------------------|-------------------|
| MA 22 EEx M II T4 24= | max. 10 bar | 5,0 Watt | T4 (135° C) |
| MA 22 EEx M II T4 110~ | max. 10 bar | 4,5 VA | T4 (135° C) |
| MA 22 EEx M II T4 230~ | max. 10 bar | 5,1 VA | T4 (135° C) |

ATEX-approved valves – Ex ia – standard temperature range – aluminum

The following solenoid valves are available:

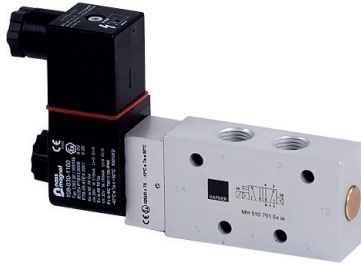

Material: Aluminum, anodized
 Zone: 1, 2, 21, 22
 Temperature range: -10°C ... +50°C
 Ignition protection type: Ex ia (intrinsically safe)
 Temperature class: T6

Marking on valve

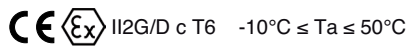

Please note:
 Maximum operating pressure for valves with Ex ia solenoid system is 8 bar!

Coil is 30 mm wide!

Solenoids are described on page 2.14.3.3.5.

Delivery contains valve with the appropriate operator system, coil, connector, manual and declaration of conformity.

| Type | Function | Port size | Installation | Further inform. on valve on page |
|---------------------|-----------------------------|-------------------|--------------|----------------------------------|
| MH 210 501 Ex ia | 2/2-way, single sol. | G 1/8" | in-line | 2.5.1.1.13 |
| MH 210 701 Ex ia | 2/2-way, single sol. | G 1/4" | in-line | 2.5.1.1.13 |
| MH 311 012 Ex ia | 3/2-way direct acting | M5 | in-line | 2.5.1.1.2 |
| MH 311 015 Ex ia | 3/2-way direct acting | G 1/8" | in-line | 2.5.1.1.2 |
| MH 310 501 Ex ia | 3/2-way, single sol. | G 1/8" | in-line | 2.5.1.1.14 |
| MOH 310 501 Ex ia | 3/2-way, n.o. single sol. | G 1/8" | in-line | 2.5.1.1.14 |
| MH 310 701 Ex ia | 3/2-way, single sol. | G 1/4" - 1/4" NPT | in-line | 2.5.1.1.14 |
| MOH 310 701 Ex ia | 3/2-way, n.o. single sol. | G 1/4" - 1/4" NPT | in-line | 2.5.1.1.14 |
| MH 310 801 Ex ia | 3/2-way, single sol. | G 1/4" | in-line | 2.5.1.1.14 |
| MOH 310 801 Ex ia | 3/2-way, n.o. single sol. | G 1/4" | in-line | 2.5.1.1.14 |
| MH 310 101 Ex ia | 3/2-way, single sol. | G 3/8" | in-line | 2.5.1.1.15 |
| MOH 310 101 Ex ia | 3/2-way, n.o. single sol. | G 3/8" | in-line | 2.5.1.1.15 |
| MH 310 121 Ex ia | 3/2-way, single sol. | G 1/2" - 1/2" NPT | in-line | 2.5.1.1.15 |
| MOH 310 121 Ex ia | 3/2-way, n.o. single sol. | G 1/2" - 1/2" NPT | in-line | 2.5.1.1.15 |
| MH 310 101 G Ex ia | 3/2-way, single sol. | G 3/8" | dual use* | 2.5.1.1.17 |
| MOH 310 101 G Ex ia | 3/2-way, n.o. single sol. | G 3/8" | dual use* | 2.5.1.1.17 |
| MH 310 121 G Ex ia | 3/2-way, single sol. | G 1/2" | dual use* | 2.5.1.1.17 |
| MOH 310 121 G Ex ia | 3/2-way, n.o. single sol. | G 1/2" | dual use* | 2.5.1.1.17 |
| MH 320 501 Ex ia | 3/2-way, double sol. | G 1/8" | in-line | 2.5.1.1.18 |
| MH 320 701 Ex ia | 3/2-way, double sol. | G 1/4" | in-line | 2.5.1.1.18 |
| MH 320 801 Ex ia | 3/2-way, double sol. | G 1/4" | in-line | 2.5.1.1.18 |
| MH 320 101 Ex ia | 3/2-way, double sol. | G 3/8" | in-line | 2.5.1.1.19 |
| MH 320 121 Ex ia | 3/2-way, double sol. | G 1/2" - 1/2" NPT | in-line | 2.5.1.1.19 |
| MH 320 121 G Ex ia | 3/2-way, double sol. | G 1/2" | dual use* | 2.5.1.1.20 |
| MH 510 501 Ex ia | 5/2-way, single sol. | G 1/8" | in-line | 2.5.2.1.3 |
| MH 510 701 Ex ia | 5/2-way, single sol. | G 1/4" - 1/4" NPT | in-line | 2.5.2.1.3 |
| MH 510 801 Ex ia | 5/2-way, single sol. | G 1/4" | in-line | 2.5.2.1.3 |
| MH 510 101 Ex ia | 5/2-way, single sol. | G 3/8" | in-line | 2.5.2.1.4 |
| MH 510 121 Ex ia | 5/2-way, single sol. | G 1/2" - 1/2" NPT | in-line | 2.5.2.1.4 |
| MH 510 101 G Ex ia | 5/2-way, single sol. | G 3/8" | dual use* | 2.5.2.1.6 |
| MH 510 121 G Ex ia | 5/2-way, single sol. | G 1/2" | dual use* | 2.5.2.1.6 |
| MH 520 501 Ex ia | 5/2-way, double sol. | G 1/8" | in-line | 2.5.2.1.9 |
| MH 520 701 Ex ia | 5/2-way, double sol. | G 1/4" - 1/4" NPT | in-line | 2.5.2.1.9 |
| MH 520 801 Ex ia | 5/2-way, double sol. | G 1/4" | in-line | 2.5.2.1.9 |
| MH 520 101 Ex ia | 5/2-way, double sol. | G 3/8" | in-line | 2.5.2.1.10 |
| MH 520 121 Ex ia | 5/2-way, double sol. | G 1/2" - 1/2" NPT | in-line | 2.5.2.1.10 |
| MH 520 101 G Ex ia | 5/2-way, double sol. | G 3/8" | dual use* | 2.5.2.1.12 |
| MH 520 121 G Ex ia | 5/2-way, double sol. | G 1/2" | dual use* | 2.5.2.1.12 |
| MH 53_ 501 Ex ia | 5/3-way, different versions | G 1/8" | in-line | 2.5.3.1.2 |
| MH 53_ 701 Ex ia | 5/3-way, different versions | G 1/4" - 1/4" NPT | in-line | 2.5.3.1.2 |
| MH 53_ 801 Ex ia | 5/3-way, different versions | G 1/4" | in-line | 2.5.3.1.2 |
| MH 53_ 101 Ex ia | 5/3-way, different versions | G 3/8" | in-line | 2.5.3.1.3 |
| MH 53_ 121 Ex ia | 5/3-way, different versions | G 1/2" - 1/2" NPT | in-line | 2.5.3.1.3 |
| MH 53_ 101 G Ex ia | 5/3-way, different versions | G 3/8" | dual use* | 2.5.3.1.5 |
| MH 53_ 121 G Ex ia | 5/3-way, different versions | G 1/2" | dual use* | 2.5.3.1.5 |

Valves with interface according to NAMUR-standard

| | | | |
|-------------------|-----------------------------|-------------------|----------------------|
| MNH 350 701 Ex ia | 3/2-way & 5/2-way | G 1/4" - 1/4" NPT | 1/4" NAMUR 2.9.1.3 |
| MNH 310 701 Ex ia | 3/2-way, single sol. | G 1/4" - 1/4" NPT | 1/4" NAMUR 2.9.1.1.1 |
| MNH 310 711 Ex ia | 3/2-way, single sol. | G 1/4" | 1/4" NAMUR 2.9.1.1.1 |
| MNH 310 121 Ex ia | 3/2-way, single sol. | G 1/2" - 1/2" NPT | 1/2" NAMUR 2.9.1.1.2 |
| MNH 510 701 Ex ia | 5/2-way, single sol. | G 1/4" - 1/4" NPT | 1/4" NAMUR 2.9.1.2.1 |
| MNH 510 711 Ex ia | 5/2-way, single sol. | G 1/4" | 1/4" NAMUR 2.9.1.2.1 |
| MNH 510 121 Ex ia | 5/2-way, single sol. | G 1/2" - 1/2" NPT | 1/2" NAMUR 2.9.1.2.2 |
| MNH 520 701 Ex ia | 5/2-way, double sol. | G 1/4" - 1/4" NPT | 1/4" NAMUR 2.9.1.2.3 |
| MNH 520 121 Ex ia | 5/2-way, double sol. | G 1/2" - 1/2" NPT | 1/2" NAMUR 2.9.1.2.3 |
| MNH 53_ 701 Ex ia | 5/3-way, different versions | G 1/4" - 1/4" NPT | 1/4" NAMUR 2.9.1.4 |
| MNH 53_ 121 Ex ia | 5/3-way, centre closed | G 1/2" - 1/2" NPT | 1/2" NAMUR 2.9.1.4 |

* dual use valves can either be used in-line or on a manifold plate.

ATEX-approved valves – Ex ia – low temperature range – aluminum



Material: Aluminum, anodized
 Zone: 1, 2, 21, 22
 Temperature range: -40°C ... +50°C ❄️
 Ignition protection type: Ex ia (intrinsically safe)
 Temperature class: T6

Marking on valve **CE** **Ex** II2G/D c T6 -40°C ≤ Ta ≤ 50°C

Please note:
 Maximum operating pressure for valves with Ex ia solenoid system is 8 bar!

Coil is 30 mm wide!

The following solenoid valves are available:

| Type | Function | Port size | Installation | Further information on valve on page |
|-----------------------|-----------------------------|-------------------|--------------|--------------------------------------|
| MH 311 012 TT Ex ia | 3/2-way direct acting | M5 | in-line | 2.11.5.1.1 |
| MH 311 015 TT Ex ia | 3/2-way direct acting | G 1/8" | in-line | 2.11.5.1.1 |
| MH 310 501 TT Ex ia | 3/2-way, single sol. | G 1/8" | in-line | 2.11.5.1.2 |
| MOH 310 501 TT Ex ia | 3/2-way, n.o. single sol. | G 1/8" | in-line | 2.11.5.1.2 |
| MH 310 701 GTT Ex ia | 3/2-way, single sol. | G 1/4" - 1/4" NPT | dual use* | 2.11.5.1.2 |
| MOH 310 701 GTT Ex ia | 3/2-way, n.o. single sol. | G 1/4" - 1/4" NPT | dual use* | 2.11.5.1.2 |
| MH 320 501 TT Ex ia | 3/2-way, double sol. | G 1/8" | in-line | 2.11.5.1.2 |
| MH 320 701 GTT Ex ia | 3/2-way, double sol. | G 1/4" | dual use* | 2.11.5.1.2 |
| MH 510 501 GTT Ex ia | 5/2-way, single sol. | G 1/8" | dual use* | 2.11.5.2.1 |
| MH 510 701 GTT Ex ia | 5/2-way, single sol. | G 1/4" - 1/4" NPT | dual use* | 2.11.5.2.1 |
| MH 520 501 GTT Ex ia | 5/2-way, double sol. | G 1/8" | dual use* | 2.11.5.2.2 |
| MH 520 701 GTT Ex ia | 5/2-way, double sol. | G 1/4" - 1/4" NPT | dual use* | 2.11.5.2.2 |
| MH 53_ 501 GTT Ex ia | 5/3-way, different versions | G 1/8" | dual use* | 2.11.5.2.2 |
| MH 53_ 701 GTT Ex ia | 5/3-way, different versions | G 1/4" - 1/4" NPT | dual use* | 2.11.5.2.2 |

Valves with interface according to NAMUR-standard

| | | | | |
|----------------------|------------------------|-------------------|------------|------------|
| MNH 310 701 TT Ex ia | 3/2-way, single sol. | G 1/4" - 1/4" NPT | 1/4" NAMUR | 2.11.6.1 |
| MNH 510 701 TT Ex ia | 5/2-way, single sol. | G 1/4" - 1/4" NPT | 1/4" NAMUR | 2.11.6.2.1 |
| MNH 510 711 TT Ex ia | 5/2-way, single sol. | G 1/4" | 1/4" NAMUR | 2.11.6.2.1 |
| MNH 520 701 TT Ex ia | 5/2-way, double sol. | G 1/4" - 1/4" NPT | 1/4" NAMUR | 2.11.6.2.2 |
| MNH 531 701 TT Ex ia | 5/3-way, centre closed | G 1/4" - 1/4" NPT | 1/4" NAMUR | 2.11.6.2.2 |



* dual use valves can either be used in-line or on a manifold plate.

Solenoids are described on page 2.14.3.3.5.
 Delivery contains valve with the appropriate operator system, coil, manual and declaration of conformity.

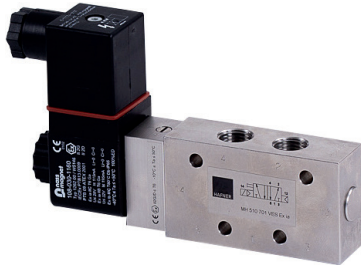
ATEX-approved valves – Ex ia – standard temperature range – stainless steel



Material: Stainless steel, 316L 
 Zone: 1, 2, 21, 22
 Temperature range: -10°C ... +50°C
 Ignition protection type: Ex ia (intrinsically safe)
 Temperature class: T6

Marking on valve   II2G/D c T6 -10°C ≤ Ta ≤ 50°C

Please note:
 Maximum operating pressure for valves with Ex ia solenoid system is 8 bar!

Coil is 30 mm wide!

The following solenoid valves are available:

| Type | Function | Port size | Installation | Further information on valve on page |
|-----------------------|-----------------------------|-------------------|--------------|--------------------------------------|
| MH 311 015 VES Ex ia | 3/2-way direct acting | G 1/8" | in-line | 2.12.4.1 |
| MH 310 701 VES Ex ia | 3/2-way, single sol. | G 1/4" - 1/4" NPT | in-line | 2.12.4.2 |
| MOH 310 701 VES Ex ia | 3/2-way, n.o. single sol. | G 1/4" - 1/4" NPT | in-line | 2.12.4.2 |
| MH 310 121 VES Ex ia | 3/2-way, single sol. | G 1/2" | in-line | 2.12.4.3 |
| MH 320 121 VES Ex ia | 3/2-way, double sol. | G 1/2" | in-line | 2.12.4.3 |
| MH 510 701 VES Ex ia | 5/2-way, single sol. | G 1/4" - 1/4" NPT | in-line | 2.12.4.4 |
| MH 510 121 VES Ex ia | 5/2-way, single sol. | G 1/2" - 1/2" NPT | in-line | 2.12.4.4 |
| MH 520 701 VES Ex ia | 5/2-way, double sol. | G 1/4" - 1/4" NPT | in-line | 2.12.4.5 |
| MH 520 121 VES Ex ia | 5/2-way, double sol. | G 1/2" - 1/2" NPT | in-line | 2.12.4.5 |
| MH 53_701 VES Ex ia | 5/3-way, different versions | G 1/4" - 1/4" NPT | in-line | 2.12.4.6 |
| MH 53_121 VES Ex ia | 5/3-way, different versions | G 1/2" - 1/2" NPT | in-line | 2.12.4.6 |

Valves with interface according to NAMUR-standard



| | | | | |
|-----------------------|----------------------|-------------------|------------|----------|
| MNH 350 701 VES Ex ia | 3/2-way & 5/2-way | G 1/4" - 1/4" NPT | 1/4" NAMUR | 2.12.5.3 |
| MNH 310 701 VES Ex ia | 3/2-way, single sol. | G 1/4" - 1/4" NPT | 1/4" NAMUR | 2.12.5.1 |
| MNH 510 701 VES Ex ia | 5/2-way, single sol. | G 1/4" - 1/4" NPT | 1/4" NAMUR | 2.12.5.2 |
| MNH 520 701 VES Ex ia | 5/2-way, double sol. | G 1/4" - 1/4" NPT | 1/4" NAMUR | 2.12.5.2 |

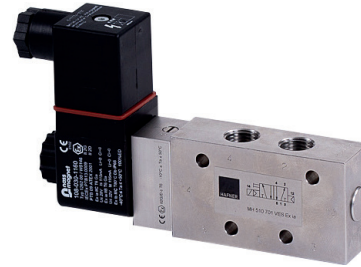

Solenoids are described on page 2.14.3.3.5.

Delivery contains valve with the appropriate operator system, coil, manual and declaration of conformity.

ATEX-approved valves – Ex ia – low temperature range – stainless steel



Material: Stainless steel, 316L 
 Zone: 1, 2, 21, 22
 Temperature range: -40°C ... +50°C 
 Ignition protection type: Ex ia (intrinsically safe)
 Temperature class: T6

Marking on valve   II2G/D c T6 -40°C ≤ Ta ≤ 50°C

Please note:
 Maximum operating pressure for valves with Ex ia
 solenoid system is 8 bar!

Coil is 30 mm wide!

The following solenoid valves are available:

| Type | Function | Port size | Installation | Further information on valve on page |
|--------------------------|-----------------------------|-------------------|--------------|--------------------------------------|
| MH 311 015 VES TT Ex ia | 3/2-way direct acting | G 1/8" | in-line | 2.12.4.1 |
| MH 310 701 VES TT Ex ia | 3/2-way, single sol. | G 1/4" - 1/4" NPT | in-line | 2.12.4.2 |
| MOH 310 701 VES TT Ex ia | 3/2-way, n.o. single sol. | G 1/4" - 1/4" NPT | in-line | 2.12.4.2 |
| MH 510 701 VES TT Ex ia | 5/2-way, single sol. | G 1/4" - 1/4" NPT | in-line | 2.12.4.4 |
| MH 520 701 VES TT Ex ia | 5/2-way, double sol. | G 1/4" - 1/4" NPT | in-line | 2.12.4.5 |
| MH 53_701 VES TT Ex ia | 5/3-way, different versions | G 1/4" - 1/4" NPT | in-line | 2.12.4.6 |

| Valves with interface according to NAMUR-standard | | | | |
|---|----------------------|-------------------|--------------|--------------------------------------|
| Type | Function | Port size | Installation | Further information on valve on page |
| MNH 350 701 VES TT Ex ia | 3/2-way & 5/2-way | G 1/4" - 1/4" NPT | 1/4" NAMUR | 2.12.5.3 |
| MNH 310 701 VES TT Ex ia | 3/2-way, single sol. | G 1/4" - 1/4" NPT | 1/4" NAMUR | 2.12.5.1 |
| MNH 510 701 VES TT Ex ia | 5/2-way, single sol. | G 1/4" - 1/4" NPT | 1/4" NAMUR | 2.12.5.2 |
| MNH 520 701 VES TT Ex ia | 5/2-way, double sol. | G 1/4" - 1/4" NPT | 1/4" NAMUR | 2.12.5.2 |

Solenoids are described on page 2.14.3.3.5.

Delivery contains valve with the appropriate operator
 system, coil, manual and declaration of conformity.

MA 30 Ex ia tD II CT6 24 DC



When this solenoid system is used in combination with „ATEX certified“ mechanical components conforming EN 13463-1:2001 and PrEN 13463-5:2000, the entire valve can be used in explosive hazardous environment zone 1, 2, 21, and 22.

ATEX approved intrinsic safety coil and connector for gas and dust explosion-hazardous environment. System is also IEC-Ex approved. Electrical connection according to DIN EN 175301-803-A / ISO 4400.

Coil:

Electrical characteristics: 21,6... 28 V DC
>37 mA
final temperature rise
18 K
275 Ohm +/-8 %

Relative duty cycle: 100 %

Temperature range: -40° ... +50° C

Insulation class of insulating materials according to DIN VDE 0580: F

Protection level with connector according to EN 60529: IP 65

Moulding material: Thermoset resin (Epoxy)

Marking on coil: II 2G Ex ia IIB/IIC T6
II 2D Ex tb IIIC T80°C

Barrier:

Electrical characteristics: 21,6... 28 V DC
Admissible peak value: 28 V DC
115 mA
1,6 W

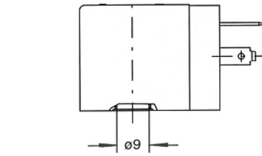

Electrical connection
DIN EN 175301-803A/ISO 4400

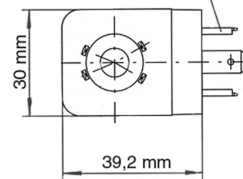

MA 30 Ex ia tD II CT6 24 DC

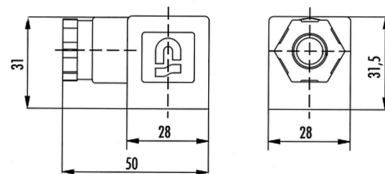

ST 30 Ex ia

Order Code: MA 30 Ex ia tD II CT6 24 DC

As the coil is 30 mm wide, a spacer plate called „ZPN 5“ has to be used, in case of combination with our NAMUR-valve series 700 refer to page 2.10.12.

ST 30 Ex ia is an ATEX approved connector, especially designed for being used in combination with the intrinsic safety coil. For dust approval (zone 21), this original connector is mandatory. Delivery includes connector ST 30 Ex ia, flat nitril gasket and fixing screw (zinc-plated steel). Form according to A - ISO 4400, no LED, no varistor, operating voltage 0 – 250 V, max. current 10 A, cable diameter 6 – 8 mm.

How to select a suitable barrier:
I/U Characteristics supply units/solenoid coil

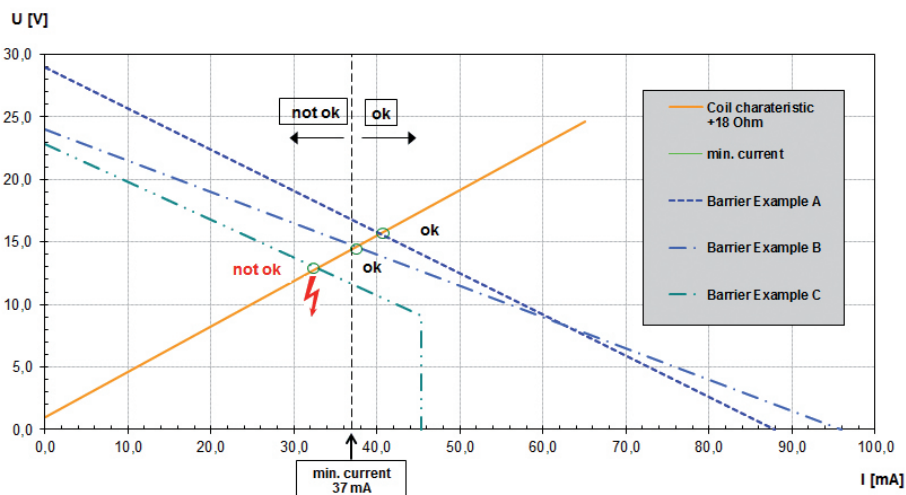

The ATEX approval is only valid as long as the associated components are used.

ATEX-approved valves – Ex nA – standard temperature range – aluminum



Material: Aluminum, anodized, head PA
 Zone: 2, 22
 Temperature range: -10°C ... +50°C
 Ignition protection type: Ex nA (non-sparking)
 Temperature class: T5

Marking on valve

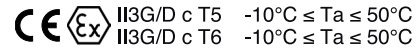

The following solenoid valves are available:

| Type | Function | Port size | Installation | Further inform. on valve | Type | Function | Port size | Installation | Further inform. on valve |
|---------------------|---------------------------|--------------|--------------|--------------------------|--------------------|-----------------------------|--------------|--------------|--------------------------|
| MH 210 501 Ex nA | 2/2-way, single sol. | G 1/8" | in-line | 2.5.1.1.13 | MH 520 101 Ex nA | 5/2-way, double sol. | G 3/8" | in-line | 2.5.2.1.10 |
| MH 210 701 Ex nA | 2/2-way, single sol. | G 1/4" | in-line | 2.5.1.1.13 | MH 520 121 Ex nA | 5/2-way, double sol. | G 1/2" - NPT | in-line | 2.5.2.1.10 |
| MH 311 012 Ex nA | 3/2-way direct acting | M5 | in-line | 2.5.1.1.2 | MH 520 501 G Ex nA | 5/2-way, double sol. | G 1/8" | dual use* | 2.5.2.1.11 |
| MH 311 015 Ex nA | 3/2-way direct acting | G 1/8" | in-line | 2.5.1.1.2 | MH 520 701 G Ex nA | 5/2-way, double sol. | G 1/4" - NPT | dual use* | 2.5.2.1.11 |
| MH 311 013 Ex nA | 3/2-way direct acting | G 1/8" | banjo screw | 2.5.1.1.8 | MH 520 101 G Ex nA | 5/2-way, double sol. | G 3/8" | dual use* | 2.5.2.1.12 |
| MH 311 017 Ex nA | 3/2-way direct acting | G 1/4" | banjo screw | 2.5.1.1.8 | MH 520 121 G Ex nA | 5/2-way, double sol. | G 1/2" | dual use* | 2.5.2.1.12 |
| MH 312 Ex nA | 3/2-way direct acting | M5 | manifold | 2.5.1.2.2 | MH 520 504 Ex nA | 5/2-way, double sol. | 5 mm orifice | manifold | 2.5.2.2.8 |
| MH 315 Ex nA | 3/2-way direct acting | G 1/8" | manifold | 2.5.1.2.2 | MH 520 704 Ex nA | 5/2-way, double sol. | 7 mm orifice | manifold | 2.5.2.2.8 |
| MH 310 501 Ex nA | 3/2-way, single sol. | G 1/8" | in-line | 2.5.1.1.14 | MH 53_501 Ex nA | 5/3-way, different versions | G 1/8" | in-line | 2.5.3.1.2 |
| MOH 310 501 Ex nA | 3/2-way, n.o. single sol. | G 1/8" | in-line | 2.5.1.1.14 | MH 53_701 Ex nA | 5/3-way, different versions | G 1/4" | in-line | 2.5.3.1.2 |
| MH 310 701 Ex nA | 3/2-way, single sol. | G 1/4" | in-line | 2.5.1.1.14 | MH 53_801 Ex nA | 5/3-way, different versions | G 1/4" | in-line | 2.5.3.1.2 |
| MOH 310 701 Ex nA | 3/2-way, n.o. single sol. | G 1/4" | in-line | 2.5.1.1.14 | MH 53_101 Ex nA | 5/3-way, different versions | G 3/8" | in-line | 2.5.3.1.3 |
| MH 310 801 Ex nA | 3/2-way, single sol. | G 1/4" | in-line | 2.5.1.1.14 | MH 53_121 Ex nA | 5/3-way, different versions | G 1/2" - NPT | in-line | 2.5.3.1.3 |
| MOH 310 801 Ex nA | 3/2-way, n.o. single sol. | G 1/4" | in-line | 2.5.1.1.14 | MH 53_501 G Ex nA | 5/3-way, different versions | G 1/8" | dual use* | 2.5.3.1.4 |
| MH 310 101 Ex nA | 3/2-way, single sol. | G 3/8" | in-line | 2.5.1.1.15 | MH 53_701 G Ex nA | 5/3-way, different versions | G 1/4" - NPT | dual use* | 2.5.3.1.4 |
| MOH 310 101 Ex nA | 3/2-way, n.o. single sol. | G 3/8" | in-line | 2.5.1.1.15 | MH 53_101 G Ex nA | 5/3-way, different versions | G 3/8" | dual use* | 2.5.3.1.5 |
| MH 310 121 Ex nA | 3/2-way, single sol. | G 1/2" - NPT | in-line | 2.5.1.1.15 | MH 53_121 G Ex nA | 5/3-way, different versions | G 1/2" | dual use* | 2.5.3.1.5 |
| MOH 310 121 Ex nA | 3/2-way, n.o. single sol. | G 1/2" - NPT | in-line | 2.5.1.1.15 | MH 53_504 Ex nA | 5/3-way, different versions | 5 mm orifice | manifold | 2.5.3.2.4 |
| MH 310 501 G Ex nA | 3/2-way, single sol. | G 1/8" | dual use* | 2.5.1.1.16 | MH 53_704 Ex nA | 5/3-way, different versions | 7 mm orifice | manifold | 2.5.3.2.4 |
| MOH 310 501 G Ex nA | 3/2-way, n.o. single sol. | G 1/8" | dual use* | 2.5.1.1.16 | | | | | |
| MH 310 701 G Ex nA | 3/2-way, single sol. | G 1/4" - NPT | dual use* | 2.5.1.1.16 | | | | | |
| MOH 310 701 G Ex nA | 3/2-way, n.o. single sol. | G 1/4" - NPT | dual use* | 2.5.1.1.16 | | | | | |
| MH 310 101 G Ex nA | 3/2-way, single sol. | G 3/8" | dual use* | 2.5.1.1.17 | | | | | |
| MOH 310 101 G Ex nA | 3/2-way, n.o. single sol. | G 3/8" | dual use* | 2.5.1.1.17 | | | | | |
| MH 310 121 G Ex nA | 3/2-way, single sol. | G 1/2" | dual use* | 2.5.1.1.17 | | | | | |
| MOH 310 121 G Ex nA | 3/2-way, n.o. single sol. | G 1/2" | dual use* | 2.5.1.1.17 | | | | | |
| MH 320 501 Ex nA | 3/2-way, double sol. | G 1/8" | in-line | 2.5.1.1.18 | | | | | |
| MH 320 701 Ex nA | 3/2-way, double sol. | G 1/4" | in-line | 2.5.1.1.18 | | | | | |
| MH 320 801 Ex nA | 3/2-way, double sol. | G 1/4" | in-line | 2.5.1.1.18 | | | | | |
| MH 320 101 Ex nA | 3/2-way, double sol. | G 3/8" | in-line | 2.5.1.1.19 | | | | | |
| MH 320 121 Ex nA | 3/2-way, double sol. | G 1/2" | in-line | 2.5.1.1.19 | | | | | |
| MH 320 501 G Ex nA | 3/2-way, double sol. | G 1/8" | dual use* | 2.5.1.1.20 | | | | | |
| MH 320 701 G Ex nA | 3/2-way, double sol. | G 1/4" | dual use* | 2.5.1.1.20 | | | | | |
| MH 320 101 G Ex nA | 3/2-way, double sol. | G 3/8" | dual use* | 2.5.1.1.20 | | | | | |
| MH 320 121 G Ex nA | 3/2-way, double sol. | G 1/2" | dual use* | 2.5.1.1.20 | | | | | |
| MH 510 501 Ex nA | 5/2-way, single sol. | G 1/8" | in-line | 2.5.2.1.3 | | | | | |
| MH 510 701 Ex nA | 5/2-way, single sol. | G 1/4" | in-line | 2.5.2.1.3 | | | | | |
| MH 510 801 Ex nA | 5/2-way, single sol. | G 1/4" | in-line | 2.5.2.1.3 | | | | | |
| MH 510 101 Ex nA | 5/2-way, single sol. | G 3/8" | in-line | 2.5.2.1.4 | | | | | |
| MH 510 121 Ex nA | 5/2-way, single sol. | G 1/2" - NPT | in-line | 2.5.2.1.4 | | | | | |
| MH 510 501 G Ex nA | 5/2-way, single sol. | G 1/8" | dual use* | 2.5.2.1.5 | | | | | |
| MH 510 701 G Ex nA | 5/2-way, single sol. | G 1/4" - NPT | dual use* | 2.5.2.1.5 | | | | | |
| MH 510 101 G Ex nA | 5/2-way, single sol. | G 3/8" | dual use* | 2.5.2.1.6 | | | | | |
| MH 510 121 G Ex nA | 5/2-way, single sol. | G 1/2" | dual use* | 2.5.2.1.6 | | | | | |
| MH 510 504 Ex nA | 5/2-way, single sol. | 5 mm orifice | manifold | 2.5.2.2.4 | | | | | |
| MH 510 704 Ex nA | 5/2-way, single sol. | 7 mm orifice | manifold | 2.5.2.2.4 | | | | | |
| MH 520 501 Ex nA | 5/2-way, double sol. | G 1/8" | in-line | 2.5.2.1.9 | | | | | |
| MH 520 701 Ex nA | 5/2-way, double sol. | G 1/4" | in-line | 2.5.2.1.9 | | | | | |
| MH 520 801 Ex nA | 5/2-way, double sol. | G 1/4" | in-line | 2.5.2.1.9 | | | | | |

| Valves with interface according to NAMUR-standard | | | | | | | | | |
|---|-----------------------------|--------------|------------|-----------|--|--|--|--|--|
| MNH 350 701 Ex nA | 3/2-way & 5/2-way | G 1/4" - NPT | 1/4" NAMUR | 2.9.1.3 | | | | | |
| MNH 310 701 Ex nA | 3/2-way, single sol. | G 1/4" - NPT | 1/4" NAMUR | 2.9.1.1.1 | | | | | |
| MNH 310 711 Ex nA | 3/2-way, single sol. | G 1/4" | 1/4" NAMUR | 2.9.1.1.1 | | | | | |
| MNH 310 121 Ex nA | 3/2-way, single sol. | G 1/2" - NPT | 1/2" NAMUR | 2.9.1.1.2 | | | | | |
| MNH 510 701 Ex nA | 5/2-way, single sol. | G 1/4" - NPT | 1/4" NAMUR | 2.9.1.2.1 | | | | | |
| MNH 510 711 Ex nA | 5/2-way, single sol. | G 1/4" | 1/4" NAMUR | 2.9.1.2.1 | | | | | |
| MNH 510 121 Ex nA | 5/2-way, single sol. | G 1/2" - NPT | 1/2" NAMUR | 2.9.1.2.2 | | | | | |
| MNH 520 701 Ex nA | 5/2-way, double sol. | G 1/4" - NPT | 1/4" NAMUR | 2.9.1.2.3 | | | | | |
| MNH 520 121 Ex nA | 5/2-way, double sol. | G 1/2" - NPT | 1/2" NAMUR | 2.9.1.2.3 | | | | | |
| MNH 53_701 Ex nA | 5/3-way, different versions | G 1/4" - NPT | 1/4" NAMUR | 2.9.1.4 | | | | | |
| MNH 531 121 Ex nA | 5/3-way, centre closed | G 1/2" - NPT | 1/2" NAMUR | 2.9.1.4 | | | | | |

* dual use valves can either be used in-line or on a manifold plate.

Solenoids are described on page 2.14.3.4.3. Delivery contains valve with the appropriate operator system, coil, manual and declaration of conformity.

ATEX-approved valves – Ex nA – standard temperature range – stainless steel

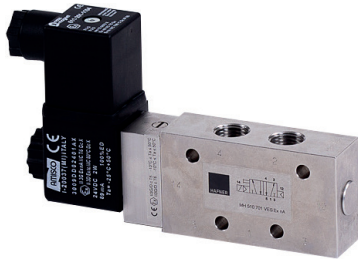

Material: Stainless steel, 316L 
 Zone: 2, 22
 Temperature range: -10°C ... +50°C
 Ignition protection type: Ex nA (non-sparking)
 Temperature class: T5

Marking on valve   II3G/D c T5 -10°C ≤ Ta ≤ 50°C
 II3G/D c T6 -10°C ≤ Ta ≤ 50°C

The following solenoid valves are available:

| Type | Function | Port size | Installation | Further information on valve on page |
|-----------------------|-----------------------------|-------------------|--------------|--------------------------------------|
| MH 311 015 VES Ex nA | 3/2-way direct acting | G 1/8" | in-line | 2.12.4.1 |
| MH 310 701 VES Ex nA | 3/2-way, single sol. | G 1/4" - 1/4" NPT | in-line | 2.12.4.2 |
| MOH 310 701 VES Ex nA | 3/2-way, n.o. single sol. | G 1/4" - 1/4" NPT | in-line | 2.12.4.2 |
| MH 310 121 VES Ex nA | 3/2-way, single sol. | G 1/2" - 1/2" NPT | in-line | 2.12.4.3 |
| MH 320 121 VES Ex nA | 3/2-way, double sol. | G 1/2" | in-line | 2.12.4.3 |
| MH 510 701 VES Ex nA | 5/2-way, single sol. | G 1/4" - 1/4" NPT | in-line | 2.12.4.4 |
| MH 510 121 VES Ex nA | 5/2-way, single sol. | G 1/2" - 1/2" NPT | in-line | 2.12.4.4 |
| MH 520 701 VES Ex nA | 5/2-way, double sol. | G 1/4" - 1/4" NPT | in-line | 2.12.4.5 |
| MH 520 121 VES Ex nA | 5/2-way, double sol. | G 1/2" - 1/2" NPT | in-line | 2.12.4.5 |
| MH 53_701 VES Ex nA | 5/3-way, different versions | G 1/4" - 1/4" NPT | in-line | 2.12.4.6 |
| MH 53_121 VES Ex nA | 5/3-way, different versions | G 1/2" - 1/2" NPT | in-line | 2.12.4.6 |

Valves with interface according to NAMUR-standard

| | | | | |
|-----------------------|----------------------|-------------------|------------|----------|
| MNH 350 701 VES Ex nA | 3/2-way & 5/2-way | G 1/4" - 1/4" NPT | 1/4" NAMUR | 2.12.5.3 |
| MNH 310 701 VES Ex nA | 3/2-way, single sol. | G 1/4" - 1/4" NPT | 1/4" NAMUR | 2.12.5.1 |
| MNH 510 701 VES Ex nA | 5/2-way, single sol. | G 1/4" - 1/4" NPT | 1/4" NAMUR | 2.12.5.2 |
| MNH 520 701 VES Ex nA | 5/2-way, double sol. | G 1/4" - 1/4" NPT | 1/4" NAMUR | 2.12.5.2 |

Solenoids are described on page 2.14.3.4.3.

Delivery contains valve with the appropriate operator system, coil, manual and declaration of conformity.

When this solenoid system is used in combination with "ATEX certified" mechanical components conforming EN 13463-1:2001 and PrEN 13463-5:2000, the entire valve can be used in explosive hazardous environment zone 2 and 22.

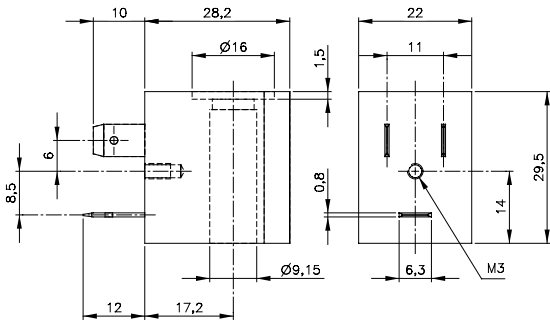

MA 22 EEx nA T5 24DC

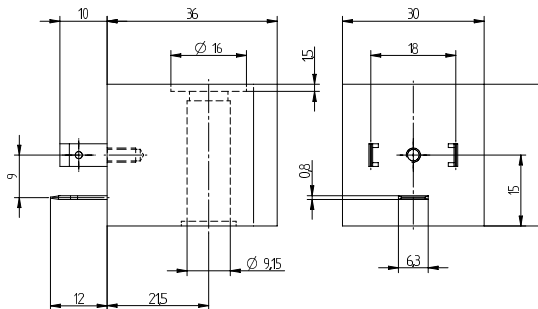

MA 30 EEx nA T6 24DC



ATEX approved non-sparking coil for gas and dust explosion-hazardous environment.

Coil:

Voltage tolerance: 24 V DC +/- 10 %

Relative duty cycle: 100 %



Temperature range: -15° ... +50° C

Insulation class of insulating materials according to DIN VDE 0580: F

Protection with connector according to EN 60529: IP 65

Moulding material: Termoplasticpolyester

Marking on coil:

T5:   II 3G Ex nA IIC T5 Gc
II 3D Ex tc IIIC 95°C Dc

T6:   II 3G Ex nA IIC T6 Gc
II 3D Ex tc IIIC 80°C Dc

Delivery content without ATEX approved connector.

30 mm wide ATEX connector available, type ST 30 Ex nA.
22 mm wide ATEX connector available, type ST 22 Ex.
Please refer to page 2.14.5.1.

The ATEX approval is only valid as long as the associated components are used.

| Type | Operating press. | Power cons. | Temp. class | Connection |
|----------------------|------------------|-------------|-------------|-----------------------------|
| MA 22 EEx nA T5 24DC | max. 10 bar | 3,0 Watt | T5 (100° C) | Industry form B (DW 436 50) |
| MA 30 EEx nA T6 24DC | max. 10 bar | 2,0 Watt | T6 (85° C) | Form A (ISO 4400) |

Other voltages are available on request.

ATEX-approved valves – Ex e mb – standard temperature range – aluminum



Material: Aluminum, anodized
 Zone: 1, 2, 21, 22
 Temperature range: -10°C ... +50°C
 Ignition protection type: Ex e mb (encapsulation with junction box)
 Temperature class: T6

Marking on valve

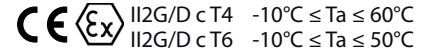

The following solenoid valves are available:

| Type | Function | Port size | Installation | Further information on valve on page |
|---------------------|-----------------------------|------------------|--------------|--------------------------------------|
| MH 310 501 Ex e mb | 3/2-way, single sol. | G 1/8" | in-line | 2.5.1.1.14 |
| MOH 310 501 Ex e mb | 3/2-way, n.o. single sol. | G 1/8" | in-line | 2.5.1.1.14 |
| MH 310 701 Ex e mb | 3/2-way, single sol. | G 1/4" -1/4" NPT | in-line | 2.5.1.1.14 |
| MOH 310 701 Ex e mb | 3/2-way, n.o. single sol. | G 1/4" -1/4" NPT | in-line | 2.5.1.1.14 |
| MH 310 801 Ex e mb | 3/2-way, single sol. | G 1/4" | in-line | 2.5.1.1.14 |
| MOH 310 801 Ex e mb | 3/2-way, n.o. single sol. | G 1/4" | in-line | 2.5.1.1.14 |
| MH 310 101 Ex e mb | 3/2-way, single sol. | G 3/8" | in-line | 2.5.1.1.15 |
| MOH 310 101 Ex e mb | 3/2-way, n.o. single sol. | G 3/8" | in-line | 2.5.1.1.15 |
| MH 310 121 Ex e mb | 3/2-way, single sol. | G 1/2" -1/2" NPT | in-line | 2.5.1.1.15 |
| MOH 310 121 Ex e mb | 3/2-way, n.o. single sol. | G 1/2" -1/2" NPT | in-line | 2.5.1.1.15 |
| MH 320 501 Ex e mb | 3/2-way, double sol. | G 1/8" | in-line | 2.5.1.1.18 |
| MH 320 701 Ex e mb | 3/2-way, double sol. | G 1/4" | in-line | 2.5.1.1.18 |
| MH 320 801 Ex e mb | 3/2-way, double sol. | G 1/4" | in-line | 2.5.1.1.18 |
| MH 320 101 Ex e mb | 3/2-way, double sol. | G 3/8" | in-line | 2.5.1.1.19 |
| MH 320 121 Ex e mb | 3/2-way, double sol. | G 1/2" | in-line | 2.5.1.1.19 |
| MH 510 501 Ex e mb | 5/2-way, single sol. | G 1/8" | in-line | 2.5.2.1.3 |
| MH 510 701 Ex e mb | 5/2-way, single sol. | G 1/4" -1/4" NPT | in-line | 2.5.2.1.3 |
| MH 510 801 Ex e mb | 5/2-way, single sol. | G 1/4" | in-line | 2.5.2.1.3 |
| MH 510 101 Ex e mb | 5/2-way, single sol. | G 3/8" | in-line | 2.5.2.1.4 |
| MH 510 121 Ex e mb | 5/2-way, single sol. | G 1/2" -1/2" NPT | in-line | 2.5.2.1.4 |
| MH 520 501 Ex e mb | 5/2-way, double sol. | G 1/8" | in-line | 2.5.2.1.9 |
| MH 520 701 Ex e mb | 5/2-way, double sol. | G 1/4" -1/4" NPT | in-line | 2.5.2.1.9 |
| MH 520 801 Ex e mb | 5/2-way, double sol. | G 1/4" | in-line | 2.5.2.1.9 |
| MH 520 101 Ex e mb | 5/2-way, double sol. | G 3/8" | in-line | 2.5.2.1.10 |
| MH 520 121 Ex e mb | 5/2-way, double sol. | G 1/2" -1/2" NPT | in-line | 2.5.2.1.10 |
| MH 53_501 Ex e mb | 5/3-way, different versions | G 1/8" | in-line | 2.5.3.1.2 |
| MH 53_701 Ex e mb | 5/3-way, different versions | G 1/4" -1/4" NPT | in-line | 2.5.3.1.2 |
| MH 53_801 Ex e mb | 5/3-way, different versions | G 1/4" | in-line | 2.5.3.1.2 |
| MH 53_101 Ex e mb | 5/3-way, different versions | G 3/8" | in-line | 2.5.3.1.3 |
| MH 53_121 Ex e mb | 5/3-way, different versions | G 1/2" -1/2" NPT | in-line | 2.5.3.1.3 |

Valves with interface according to NAMUR-standard

| | | | | |
|---------------------|-----------------------------|------------------|------------|-----------|
| MNH 350 701 Ex e mb | 3/2-way & 5/2-way | G 1/4" -1/4" NPT | 1/4" NAMUR | 2.9.1.3 |
| MNH 310 701 Ex e mb | 3/2-way, single sol. | G 1/4" -1/4" NPT | 1/4" NAMUR | 2.9.1.1.1 |
| MNH 310 711 Ex e mb | 3/2-way, single sol. | G 1/4" | 1/4" NAMUR | 2.9.1.1.1 |
| MNH 310 121 Ex e mb | 3/2-way, single sol. | G 1/2" -1/2" NPT | 1/2" NAMUR | 2.9.1.1.2 |
| MNH 510 701 Ex e mb | 5/2-way, single sol. | G 1/4" -1/4" NPT | 1/4" NAMUR | 2.9.1.2.1 |
| MNH 510 711 Ex e mb | 5/2-way, single sol. | G 1/4" | 1/4" NAMUR | 2.9.1.2.1 |
| MNH 510 121 Ex e mb | 5/2-way, single sol. | G 1/2" -1/2" NPT | 1/2" NAMUR | 2.9.1.2.2 |
| MNH 520 701 Ex e mb | 5/2-way, double sol. | G 1/4" -1/4" NPT | 1/4" NAMUR | 2.9.1.2.3 |
| MNH 520 121 Ex e mb | 5/2-way, double sol. | G 1/2" -1/2" NPT | 1/2" NAMUR | 2.9.1.2.3 |
| MNH 53_701 Ex e mb | 5/3-way, different versions | G 1/4" -1/4" NPT | 1/4" NAMUR | 2.9.1.4 |
| MNH 531 121 Ex e mb | 5/3-way, centre closed | G 1/2" -1/2" NPT | 1/2" NAMUR | 2.9.1.4 |

Solenoids are described on page 2.14.3.5.4.

Example drawings including the solenoid are displayed on page 2.14.3.5.5.

Delivery contains valve with the appropriate operator system, coil, manual and declaration of conformity.

ATEX-approved valves – Ex e mb – low temperature range – aluminum



Material: Aluminum, anodized
 Zone: 1, 2, 21, 22
 Temperature range: -40°C ... +50°C ❄️
 Ignition protection type: Ex e mb (encapsulation with junction box)
 Temperature class: T6

Marking on valve



The following solenoid valves are available:

| Type | Function | Port size | Installation | Further information on valve on page |
|-------------------------|-----------------------------|-------------------|--------------|--------------------------------------|
| MH 310 501 TT Ex e mb | 3/2-way, single sol. | G 1/8" | in-line | 2.11.5.1.2 |
| MOH 310 501 TT Ex e mb | 3/2-way, n.o. single sol. | G 1/8" | in-line | 2.11.5.1.2 |
| MH 310 701 GTT Ex e mb | 3/2-way, single sol. | G 1/4" - 1/4" NPT | in-line | 2.11.5.1.2 |
| MOH 310 701 GTT Ex e mb | 3/2-way, n.o. single sol. | G 1/4" - 1/4" NPT | in-line | 2.11.5.1.2 |
| MH 320 501 TT Ex e mb | 3/2-way, double sol. | G 1/8" | in-line | 2.11.5.1.2 |
| MH 320 701 TT Ex e mb | 3/2-way, double sol. | G 1/4" | in-line | 2.11.5.1.2 |
| MH 510 501 GTT Ex e mb | 5/2-way, single sol. | G 1/8" | in-line | 2.11.5.2.1 |
| MH 510 701 GTT Ex e mb | 5/2-way, single sol. | G 1/4" - 1/4" NPT | in-line | 2.11.5.2.1 |
| MH 520 501 GTT Ex e mb | 5/2-way, double sol. | G 1/8" | in-line | 2.11.5.2.2 |
| MH 520 701 GTT Ex e mb | 5/2-way, double sol. | G 1/4" - 1/4" NPT | in-line | 2.11.5.2.2 |
| MH 53_ 501 GTT Ex e mb | 5/3-way, different versions | G 1/8" | in-line | 2.11.5.2.2 |
| MH 53_ 701 GTT Ex e mb | 5/3-way, different versions | G 1/4" - 1/4" NPT | in-line | 2.11.5.2.2 |

Valves with interface according to NAMUR-standard

| | | | | |
|------------------------|------------------------|-------------------|------------|------------|
| MNH 310 701 TT Ex e mb | 3/2-way, single sol. | G 1/4" - 1/4" NPT | 1/4" NAMUR | 2.11.6.1 |
| MNH 510 701 TT Ex e mb | 5/2-way, single sol. | G 1/4" - 1/4" NPT | 1/4" NAMUR | 2.11.6.2.1 |
| MNH 510 711 TT Ex e mb | 5/2-way, single sol. | G 1/4" | 1/4" NAMUR | 2.11.6.2.1 |
| MNH 520 701 TT Ex e mb | 5/2-way, double sol. | G 1/4" - 1/4" NPT | 1/4" NAMUR | 2.11.6.2.2 |
| MNH 531 701 TT Ex e mb | 5/3-way, centre closed | G 1/4" - 1/4" NPT | 1/4" NAMUR | 2.11.6.2.2 |



Solenoids are described on page 2.14.3.5.4.

Example drawings including the solenoid are displayed on page 2.14.3.5.5.

Delivery contains valve with the appropriate operator system, coil, manual and declaration of conformity.

ATEX-approved valves – Ex e mb – low temperature range – stainless steel



Material: Stainless steel, 316L 
 Zone: 1, 2, 21, 22
 Temperature range: -40°C ... +50°C 
 Ignition protection type: Ex e mb (encapsulation with junction box)
 Temperature class: T6

Marking on valve   II2G/D c T4 -40°C ≤ Ta ≤ 60°C
 II2G/D c T6 -40°C ≤ Ta ≤ 50°C

The following solenoid valves are available:

| Type | Function | Port size | Installation | Further information on valve on page |
|----------------------------|----------------------------|-------------------|--------------|--------------------------------------|
| MH 310 701 VES TT Ex e mb | 3/2-way, single sol. | G 1/4" - 1/4" NPT | in-line | 2.12.4.2 |
| MOH 310 701 VES TT Ex e mb | 3/2-way, n.o. single sol. | G 1/4" - 1/4" NPT | in-line | 2.12.4.2 |
| MH 510 701 VES TT Ex e mb | 5/2-way, single sol. | G 1/4" - 1/4" NPT | in-line | 2.12.4.4 |
| MH 520 701 VES TT Ex e mb | 5/2-way, double sol. | G 1/4" - 1/4" NPT | in-line | 2.12.4.5 |
| MH 53_701 VES TT Ex e mb | 5/3-way, different version | G 1/4" - 1/4" NPT | in-line | 2.12.4.6 |

Valves with interface according to NAMUR-standard

| | | | | |
|----------------------------|----------------------|-------------------|------------|----------|
| MNH 350 701 VES TT Ex e mb | 3/2-way & 5/2-way | G 1/4" - 1/4" NPT | 1/4" NAMUR | 2.12.5.3 |
| MNH 310 701 VES TT Ex e mb | 3/2-way, single sol. | G 1/4" - 1/4" NPT | 1/4" NAMUR | 2.12.5.1 |
| MNH 310 711 VES TT Ex e mb | 3/2-way, single sol. | G 1/4" | 1/4" NAMUR | 2.12.5.1 |
| MNH 510 701 VES TT Ex e mb | 5/2-way, single sol. | G 1/4" - 1/4" NPT | 1/4" NAMUR | 2.12.5.2 |
| MNH 510 711 VES TT Ex e mb | 5/2-way, single sol. | G 1/4" | 1/4" NAMUR | 2.12.5.2 |
| MNH 520 701 VES TT Ex e mb | 5/2-way, double sol. | G 1/4" - 1/4" NPT | 1/4" NAMUR | 2.12.5.2 |

Solenoids are described on page 2.14.3.5.4.

Example drawings including the solenoid are displayed on page 2.14.3.5.5.

Delivery contains valve with the appropriate operator system, coil, manual and declaration of conformity.
 1/2" stainless steel valves in standard temperature range on request.

When this solenoid system is used in combination with "ATEX certified" mechanical components conforming EN 13463-1:2001 and PrEN 13463-5:2000, the entire valve can be used in explosive hazardous environment zone 1, 2, 21 and 22.

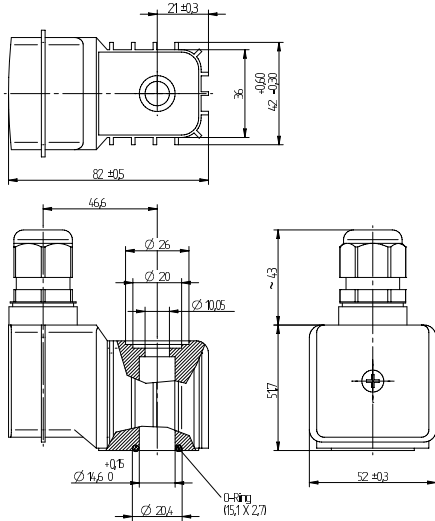

MA 52 EEx e mb IIC T6

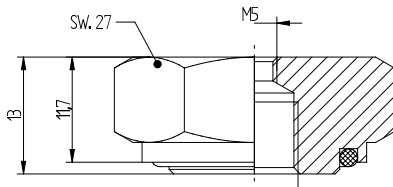

M G1/8 M5

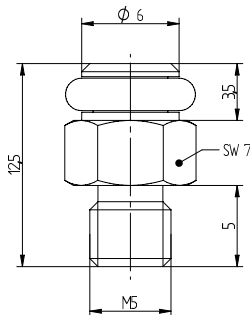

ESR M5



Details of junction box

ATEX approved encapsulated coil with junction box for gas and dust explosion-hazardous environment.

Voltage tolerance: - 10...+ 10%

Relative duty cycle: 100 %

Temperature range: -40°C...+50°C

Insulation class of insulating Materials according to DIN VDE 0580:

F

Protection according to EN 60529:

IP 65

(IP 67 with nut type M G1/8 M5 in combination with exhaust protection fitting type ESR M5)

Moulding material:

Thermoplasticpolyester

Cable Gland:

M20 x 1,5
for cable diameters
6 – 13 mm

Please note:

Same coil for DC and AC.

Marking on coil:

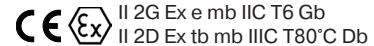

The ATEX approval is only valid as long as the associated components are used.

| Type | Operating press. | Power cons. | Temperature class |
|---------------------------|------------------|-------------|-------------------|
| MA 52 EEx e mb IIC T6 24 | max. 10 bar | 4,8 Watt | T6 (85° C) |
| MA 52 EEx e mb IIC T6 110 | max. 10 bar | 4,8 Watt | T6 (85° C) |
| MA 52 EEx e mb IIC T6 230 | max. 10 bar | 4,8 Watt | T6 (85° C) |

Example drawings of solenoid valves with Ex e mb solenoid system

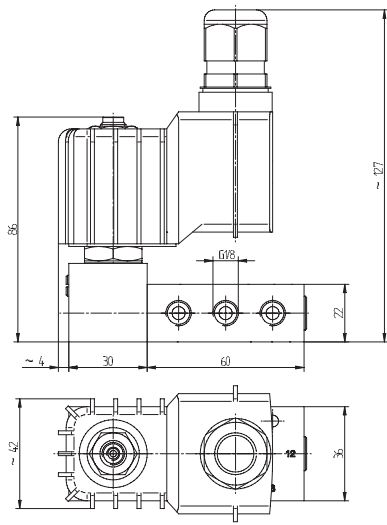

MH 510 501 Ex e mb IIC T6

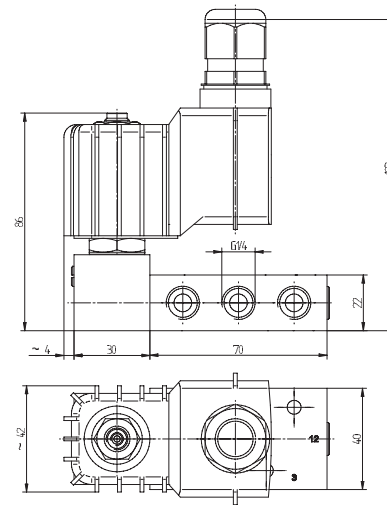
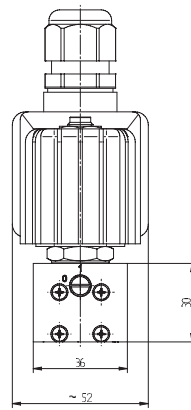

MH 510 701 Ex e mb IIC T6 /
MNH 510 701 EX e mb IIC T6

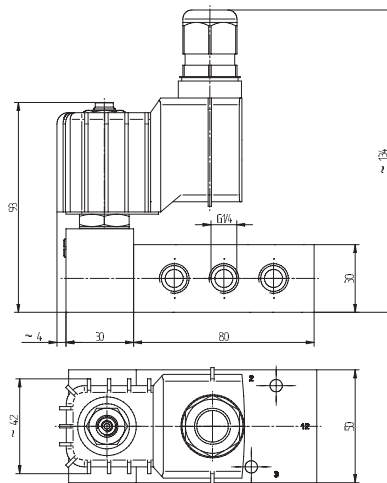

MH 510 801 Ex e mb IIC T6

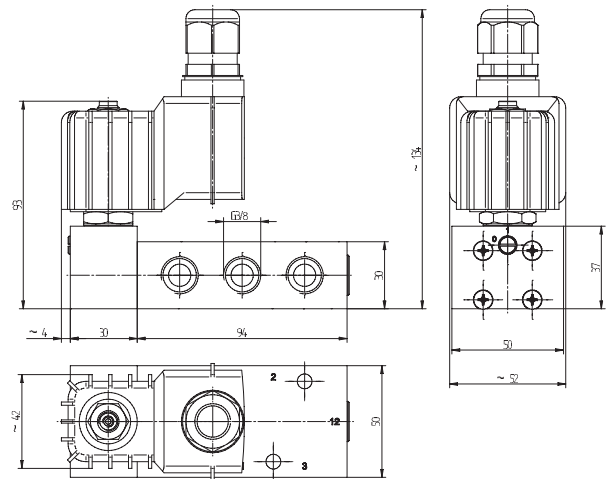
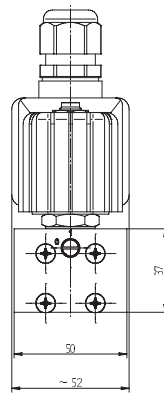

MH 510 101 Ex e mb IIC T6

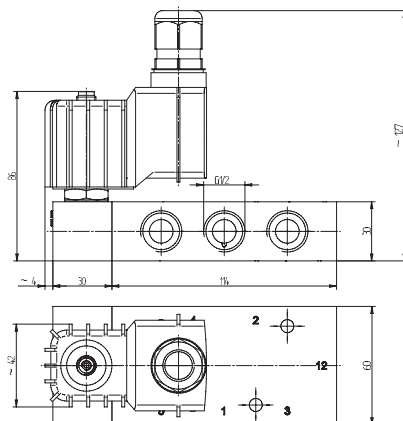

MH 510 121 Ex e mb IIC T6 /
MNH 510 121 Ex e mb IIC T6

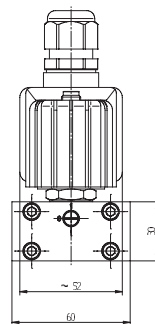

ATEX-approved valves – Ex d – standard temperature range – aluminum

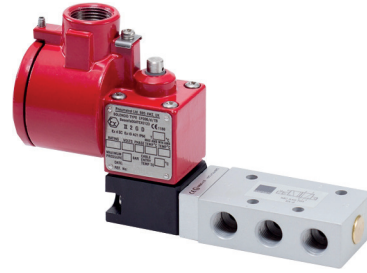



Interface between valve body and solenoid system according to CNOMO, therefore the types are called MC.

Base plate assembly due to solenoid coil is not possible.

Flameproof solenoids are displayed on page 2.14.3.6.5.

Example drawings including the solenoid are displayed on page 2.14.3.6.6.

Material: Aluminum, anodized
 Zone: 1, 2, 21, 22
 Temperature range: -10°C ... +50°C
 Solenoid coil limited to +40°C
 Ignition protection type: Ex d – flameproof
 Temperature class: T6 (solenoid)

Marking on valve   II2G/D c T6 -10°C ≤ Ta ≤ 40°C

The following solenoid valves are available:

| Type | Function | Port size | Installation | Further information on valve on page |
|------------------|----------------------------|-----------|--------------|--------------------------------------|
| MC 210 501 Ex d | 2/2-way, single sol. | G 1/8" | in-line | 2.5.1.1.13 |
| MC 210 701 Ex d | 2/2-way, single sol. | G 1/4" | in-line | 2.5.1.1.13 |
| MC 310 501 Ex d | 3/2-way, single sol. | G 1/8" | in-line | 2.5.1.1.14 |
| MOC 310 501 Ex d | 3/2-way, n.o. single sol. | G 1/8" | in-line | 2.5.1.1.14 |
| MC 310 701 Ex d | 3/2-way, single sol. | G 1/4" | in-line | 2.5.1.1.14 |
| MOC 310 701 Ex d | 3/2-way, n.o. single sol. | G 1/4" | in-line | 2.5.1.1.14 |
| MC 310 121 Ex d | 3/2-way, single sol. | G 1/2" | in-line | 2.5.1.1.15 |
| MOC 310 121 Ex d | 3/2-way, n.o. single sol. | G 1/2" | in-line | 2.5.1.1.15 |
| MC 320 501 Ex d | 3/2-way, double sol. | G 1/8" | in-line | 2.5.1.1.18 |
| MC 320 701 Ex d | 3/2-way, double sol. | G 1/4" | in-line | 2.5.1.1.18 |
| MC 320 121 Ex d | 3/2-way, double sol. | G 1/2" | in-line | 2.5.1.1.19 |
| MC 510 501 Ex d | 5/2-way, single sol. | G 1/8" | in-line | 2.5.2.1.3 |
| MC 510 701 Ex d | 5/2-way, single sol. | G 1/4" | in-line | 2.5.2.1.3 |
| MC 510 121 Ex d | 5/2-way, single sol. | G 1/2" | in-line | 2.5.2.1.4 |
| MC 520 501 Ex d | 5/2-way, double sol. | G 1/8" | in-line | 2.5.2.1.9 |
| MC 520 701 Ex d | 5/2-way, double sol. | G 1/4" | in-line | 2.5.2.1.9 |
| MC 520 121 Ex d | 5/2-way, double sol. | G 1/2" | in-line | 2.5.2.1.10 |
| MC 53_ 501 Ex d | 5/3-way, different version | G 1/8" | in-line | 2.5.3.1.2 |
| MC 53_ 701 Ex d | 5/3-way, different version | G 1/4" | in-line | 2.5.3.1.2 |
| MC 53_ 121 Ex d | 5/3-way, different version | G 1/2" | in-line | 2.5.3.1.3 |

Valves with interface according to NAMUR-standard

| | | | | |
|------------------|----------------------------|--------|------------|-----------|
| MNC 350 701 Ex d | 3/2-way & 5/2-way | G 1/4" | 1/4" NAMUR | 2.9.1.3 |
| MNC 310 701 Ex d | 3/2-way, single sol. | G 1/4" | 1/4" NAMUR | 2.9.1.1.1 |
| MNC 310 711 Ex d | 3/2-way, single sol. | G 1/4" | 1/4" NAMUR | 2.9.1.1.1 |
| MNC 310 121 Ex d | 3/2-way, single sol. | G 1/2" | 1/2" NAMUR | 2.9.1.1.2 |
| MNC 510 701 Ex d | 5/2-way, single sol. | G 1/4" | 1/4" NAMUR | 2.9.1.2.1 |
| MNC 510 711 Ex d | 5/2-way, single sol. | G 1/4" | 1/4" NAMUR | 2.9.1.2.1 |
| MNC 510 121 Ex d | 5/2-way, single sol. | G 1/2" | 1/2" NAMUR | 2.9.1.2.2 |
| MNC 520 701 Ex d | 5/2-way, double sol. | G 1/4" | 1/4" NAMUR | 2.9.1.2.3 |
| MNC 520 121 Ex d | 5/2-way, double sol. | G 1/2" | 1/2" NAMUR | 2.9.1.2.3 |
| MNC 53_ 701 Ex d | 5/3-way, different version | G 1/4" | 1/4" NAMUR | 2.9.1.4 |
| MNC 53_ 121 Ex d | 5/3-way, different version | G 1/2" | 1/2" NAMUR | 2.9.1.4 |

Delivery contains valve with appropriate operator system, coil, manual and declaration of conformity.

ATEX-approved valves – Ex d – low temperature range – aluminium

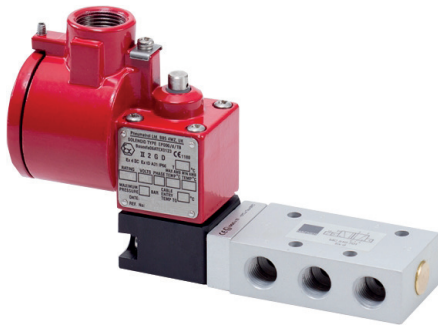

Material: Aluminum, anodized
 Zone: 1, 2, 21, 22
 Temperature range: -50°C ... +50°C ❄️
 Solenoid coil limited to +40°C
 Ignition protection type: Ex d – flameproof
 Temperature class: T6 (solenoid)

Interface between valve body and solenoid system according to CNOMO, therefore the types are called MC.

Base plate assembly due to solenoid coil is not possible.

Marking on valve  II2G/D c T6 -50°C ≤ Ta ≤ 40°C

Flameproof solenoids type MA 52 EEx d IIC T6 24DC VES are displayed on page 2.14.3.6.5.

Example drawings including the solenoid are displayed on page 2.14.3.6.6.

The following solenoid valves are available:

| Type | Function | Port size | Installation | Further information on valve on page |
|----------------------|----------------------------|-------------------|--------------|--------------------------------------|
| MC 310 501 TT Ex d | 3/2-way, single sol. | G 1/8" | in-line | 2.11.5.1.2 |
| MOC 310 501 TT Ex d | 3/2-way, n.o. single sol. | G 1/8" | in-line | 2.11.5.1.2 |
| MC 310 701 GTT Ex d | 3/2-way, single sol. | G 1/4" - 1/4" NPT | in-line | 2.11.5.1.2 |
| MOC 310 701 GTT Ex d | 3/2-way, n.o. single sol. | G 1/4" - 1/4" NPT | in-line | 2.11.5.1.2 |
| MC 320 501 TT Ex d | 3/2-way, double sol. | G 1/8" | in-line | 2.11.5.1.2 |
| MC 320 701 GTT Ex d | 3/2-way, double sol. | G 1/4" | in-line | 2.11.5.1.2 |
| MC 510 501 GTT Ex d | 5/2-way, single sol. | G 1/8" | in-line | 2.11.5.2.1 |
| MC 510 701 GTT Ex d | 5/2-way, single sol. | G 1/4" - 1/4" NPT | in-line | 2.11.5.2.1 |
| MC 520 501 GTT Ex d | 5/2-way, double sol. | G 1/8" | in-line | 2.11.5.2.2 |
| MC 520 701 GTT Ex d | 5/2-way, double sol. | G 1/4" - 1/4" NPT | in-line | 2.11.5.2.2 |
| MC 53_501 GTT Ex d | 5/3-way, different version | G 1/8" | in-line | 2.11.5.2.2 |
| MC 53_701 GTT Ex d | 5/3-way, different version | G 1/4" - 1/4" NPT | in-line | 2.11.5.2.2 |

| Valves with interface according to NAMUR-standard | | | | |
|---|----------------------------|-------------------|------------|------------|
| MNC 310 701 TT Ex d | 3/2-way, single sol. | G 1/4" - 1/4" NPT | 1/4" NAMUR | 2.11.6.1 |
| MNC 510 701 TT Ex d | 5/2-way, single sol. | G 1/4" - 1/4" NPT | 1/4" NAMUR | 2.11.6.2.1 |
| MNC 510 711 TT Ex d | 5/2-way, single sol. | G 1/4" | 1/4" NAMUR | 2.11.6.2.1 |
| MNC 520 701 TT Ex d | 5/2-way, double sol. | G 1/4" - 1/4" NPT | 1/4" NAMUR | 2.11.6.2.2 |
| MNC 531 701 TT Ex d | 5/3-way, different version | G 1/4" - 1/4" NPT | 1/4" NAMUR | 2.11.6.2.2 |

Delivery contains valve with appropriate operator system, coil, manual and declaration of conformity.

ATEX-approved valves – Ex d – standard temperature range – stainless steel





Interface between valve body and solenoid system according to CNOMO, therefore the types are called MC.

Base plate assembly due to solenoid coil is not possible.

Flameproof solenoids type MA 52 EEx d IIC T6 24DC VES are displayed on page 2.14.3.6.5.

Example drawings including the solenoid are displayed on page 2.14.3.6.6.

Material: Stainless steel, 316L 
 Zone: 1, 2, 21, 22
 Temperature range: -10°C ... +50°C
 Solenoid coil limited to +40°C
 Ignition protection type: Ex d – flameproof
 Temperature class: T6 solenoid

Marking on valve   II2G/D c T6 -10°C ≤ Ta ≤ 40°C

The following **solenoid valves** are available:

| Type | Function | Port size | Installation | Further information on valve on page |
|----------------------|----------------------------|-----------|--------------|--------------------------------------|
| MC 310 701 VES Ex d | 3/2-way, single sol. | G 1/4" | in-line | 2.12.4.2 |
| MOC 310 701 VES Ex d | 3/2-way, n.o. single sol. | G 1/4" | in-line | 2.12.4.2 |
| MC 310 121 VES Ex d | 3/2-way, single sol. | G 1/2" | in-line | 2.12.4.3 |
| MC 510 701 VES Ex d | 5/2-way, single sol. | G 1/4" | in-line | 2.12.4.4 |
| MC 510 121 VES Ex d | 5/2-way, single sol. | G 1/2" | in-line | 2.12.4.4 |
| MC 520 701 VES Ex d | 5/2-way, double sol. | G 1/4" | in-line | 2.12.4.5 |
| MC 520 121 VES Ex d | 5/2-way, double sol. | G 1/2" | in-line | 2.12.4.5 |
| MC 53_ 701 VES Ex d | 5/3-way, different version | G 1/4" | in-line | 2.12.4.6 |
| MC 53_ 121 VES Ex d | 5/3-way, different version | G 1/2" | in-line | 2.12.4.6 |

| Valves with interface according to NAMUR-standard | | | | |
|---|----------------------|--------|------------|----------|
| MNC 350 701 VES Ex d | 3/2-way & 5/2-way | G 1/4" | 1/4" NAMUR | 2.12.5.3 |
| MNC 310 701 VES Ex d | 3/2-way, single sol. | G 1/4" | 1/4" NAMUR | 2.12.5.1 |
| MNC 510 701 VES Ex d | 5/2-way, single sol. | G 1/4" | 1/4" NAMUR | 2.12.5.2 |
| MNC 520 701 VES Ex d | 5/2-way, double sol. | G 1/4" | 1/4" NAMUR | 2.12.5.2 |

Delivery contains valve with appropriate operator system, coil, manual and declaration of conformity.

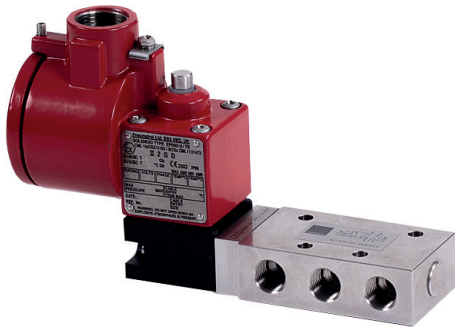

ATEX-approved valves – Ex d – low temperature range – stainless steel



Material: Stainless steel, 316L 
 Zone: 1, 2, 21, 22
 Temperature range: -50°C ... +50°C ❄️
 Solenoid coil limited to +40°C
 Ignition protection type: Ex d – flameproof
 Temperature class: T6 (solenoid)

Interface between valve body and solenoid system according to CNOMO, therefore the types are called MC.

Base plate assembly due to solenoid coil is not possible.

Marking on valve   II2G/D c T6 -50°C ≤ Ta ≤ 40°C

Flameproof solenoids type MA 52 EEx d IIC T6 24DC VES are displayed on page 2.14.3.6.5.

Example drawings including the solenoid are displayed on page 2.14.3.6.6.

The following solenoid valves are available:

| Type | Function | Port size | Installation | Further information on valve on page |
|-------------------------|----------------------------|-----------|--------------|--------------------------------------|
| MC 310 701 VES TT Ex d | 3/2-way, single sol. | G 1/4" | in-line | 2.12.4.2 |
| MOC 310 701 VES TT Ex d | 3/2-way, n.o. single sol. | G 1/4" | in-line | 2.12.4.2 |
| MC 510 701 VES TT Ex d | 5/2-way, single sol. | G 1/4" | in-line | 2.12.4.4 |
| MC 520 701 VES TT Ex d | 5/2-way, double sol. | G 1/4" | in-line | 2.12.4.5 |
| MC 53_701 VES TT Ex d | 5/3-way, different version | G 1/4" | in-line | 2.12.4.6 |

| Valves with interface according to NAMUR-standard | | | | |
|---|----------------------|-----------|--------------|--------------------------------------|
| Type | Function | Port size | Installation | Further information on valve on page |
| MNC 350 701 VES TT Ex d | 3/2-way & 5/2-way | G 1/4" | 1/4" NAMUR | 2.12.5.3 |
| MNC 310 701 VES TT Ex d | 3/2-way, single sol. | G 1/4" | 1/4" NAMUR | 2.12.5.1 |
| MNC 510 701 VES TT Ex d | 5/2-way, single sol. | G 1/4" | 1/4" NAMUR | 2.12.5.2 |
| MNC 520 701 VES TT Ex d | 5/2-way, double sol. | G 1/4" | 1/4" NAMUR | 2.12.5.2 |

When this solenoid system is used in combination with "ATEX certified" mechanical components conforming EN 13463-1:2001 and PrEN 13463-5:2000, the entire valve can be used in explosive hazardous environment zone 1, 2, 21 and 22.

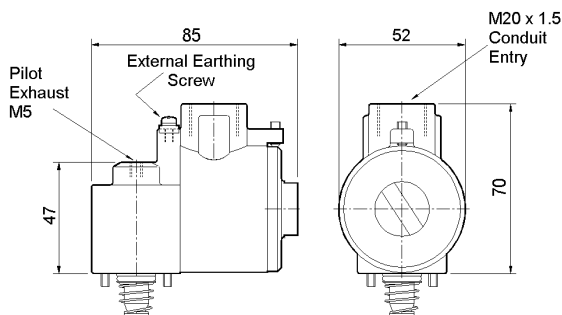
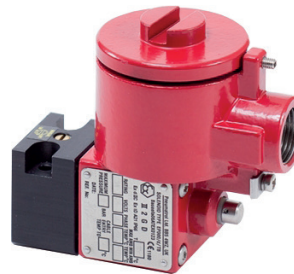

MA 52 EEx D IIC T₆__ (VES)

ATEX approved flameproof coil for gas and dust explosion hazardous environment.
Solenoids with IEC-Ex certificate on request.

Voltage: 24VDC, 110VAC, 240VAC
Voltage tolerance: - 10...+ 10 %
Relative duty cycle: 100 %
Temperature range: -65°C...+40°C,
valve limited to -50°C

Ignition protection type: flameproof

Protection according to ENBS60529 : 1992 : IP 66 with appropriate cable gland

Material solenoid coil: Stainless Steel

Coil rating according to DIN VDE 0580: Class F

Cable Gland: M20 x 1.5

Marking on coil: DC-Version:

CE Ex II 2G Ex db IIC T₆ Gb
II 2D Ex tb IIIC T₈₅°C Db

AC-Versions:

CE Ex II 2G Ex db IIC T₄ Gb
II 2D Ex tb IIIC T₁₃₅°C Db

Technical details pilot head :

Material : Standard: Aluminum
Type VES: Stainless Steel

Manual override: bistable to turn,
others on request

The ATEX approval is only valid as long as the associated components are used.

Delivery content without cable gland. Ex d rated cable glands can be supplied on request.

| Type | Operating press. | Power cons. | Temperature class |
|--|------------------|-------------|-------------------------|
| MA 52 EEx d IIC T ₆ 24 DC | max. 10 bar | 3,0 Watt | T ₆ (85° C) |
| MA 52 EEx d IIC T ₆ 24 DC VES | max. 10 bar | 3,0 Watt | T ₆ (85° C) |
| MA 52 EEx d IIC T ₄ 110AC | max. 10 bar | 9,6 VA | T ₄ (135° C) |
| MA 52 EEx d IIC T ₄ 110AC VES | max. 10 bar | 9,6 VA | T ₄ (135° C) |
| MA 52 EEx d IIC T ₄ 240AC | max. 10 bar | 9,6 VA | T ₄ (135° C) |
| MA 52 EEx d IIC T ₄ 240AC VES | max. 10 bar | 9,6 VA | T ₄ (135° C) |

Example drawings of solenoid valves with Ex d solenoid system

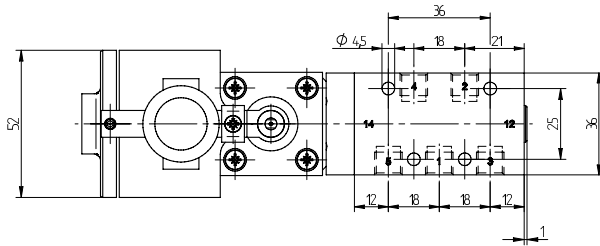

MC 510 501 Ex d

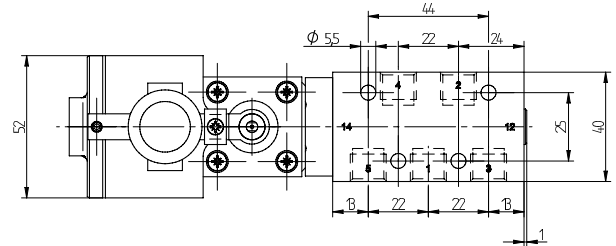

MC 510 701 Ex d/
MNC 510 701 Ex d

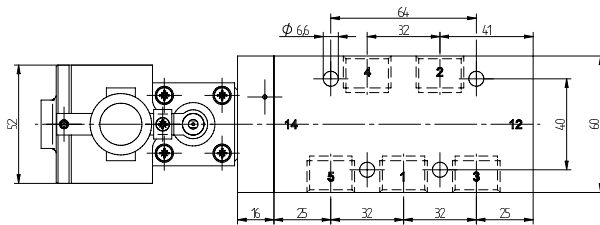

MC 510 121 Ex d/
MNC 510 121 Ex d

ATEX-approved valves – Ex dm – standard temperature range – aluminum

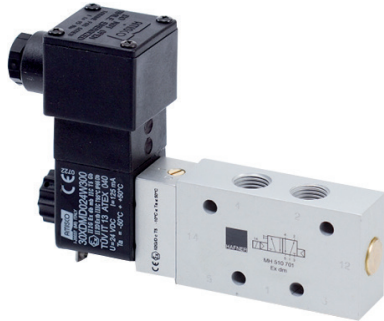

Material: Aluminum, anodized
 Zone: 1, 2, 21, 22
 Temperature range: -10°C ... +50°C
 Ignition protection type: Ex dm (encapsulated-flameproof with junction box)
 Temperature class: T5

Marking on valve:  II2G/D c T5 -10°C ≤ Ta ≤ 50°C

Base plate assembly due to width of solenoid coil (36 mm) is not possible.

Encapsulated flameproof solenoids are displayed on page 2.14.3.7.5.

The following solenoid valves are available:

| Type | Function | Port size | Installation | Further inform. on valve | Valves with interface according to NAMUR-standard | | | | |
|-------------------|----------------------------|-----------|--------------|--------------------------|---|----------------------------|-----------|--------------|--------------------------|
| Type | Function | Port size | Installation | Further inform. on valve | Type | Function | Port size | Installation | Further inform. on valve |
| MH 210 501 Ex dm | 2/2-way, single sol. | G 1/8" | in-line | 2.5.1.1.13 | MNH 350 701 Ex dm | 3/2-way & 5/2-way | G 1/4" | 1/4" NAMUR | 2.9.1.3 |
| MH 210 701 Ex dm | 2/2-way, single sol. | G 1/4" | in-line | 2.5.1.1.13 | MNH 310 701 Ex dm | 3/2-way, single sol. | G 1/4" | 1/4" NAMUR | 2.9.1.1.1 |
| MH 311 012 Ex dm | 3/2-way direct acting | M5 | in-line | 2.5.1.1.2 | MNH 310 711 Ex dm | 3/2-way, single sol. | G 1/4" | 1/4" NAMUR | 2.9.1.1.1 |
| MH 311 015 Ex dm | 3/2-way direct acting | G 1/8" | in-line | 2.5.1.1.2 | MNH 310 121 Ex dm | 3/2-way, single sol. | G 1/2" | 1/2" NAMUR | 2.9.1.1.2 |
| MH 310 501 Ex dm | 3/2-way, single sol. | G 1/8" | in-line | 2.5.1.1.14 | MNH 510 701 Ex dm | 5/2-way, single sol. | G 1/4" | 1/4" NAMUR | 2.9.1.2.1 |
| MOH 310 501 Ex dm | 3/2-way, n.o. single sol. | G 1/8" | in-line | 2.5.1.1.14 | MNH 510 711 Ex dm | 5/2-way, single sol. | G 1/4" | 1/4" NAMUR | 2.9.1.2.1 |
| MH 310 701 Ex dm | 3/2-way, single sol. | G 1/4" | in-line | 2.5.1.1.14 | MNH 510 121 Ex dm | 5/2-way, single sol. | G 1/2" | 1/2" NAMUR | 2.9.1.2.2 |
| MOH 310 701 Ex dm | 3/2-way, n.o. single sol. | G 1/4" | in-line | 2.5.1.1.14 | MNH 520 701 Ex dm | 5/2-way, double sol. | G 1/4" | 1/4" NAMUR | 2.9.1.2.3 |
| MH 310 801 Ex dm | 3/2-way, single sol. | G 1/4" | in-line | 2.5.1.1.14 | MNH 520 121 Ex dm | 5/2-way, double sol. | G 1/2" | 1/2" NAMUR | 2.9.1.2.3 |
| MOH 310 801 Ex dm | 3/2-way, n.o. single sol. | G 1/4" | in-line | 2.5.1.1.14 | MNH 53_701 Ex dm | 5/3-way, different version | G 1/4" | 1/4" NAMUR | 2.9.1.4 |
| MH 310 101 Ex dm | 3/2-way, single sol. | G 3/8" | in-line | 2.5.1.1.15 | MNH 53_121 Ex dm | 5/3-way, different version | G 1/2" | 1/2" NAMUR | 2.9.1.4 |
| MOH 310 101 Ex dm | 3/2-way, n.o. single sol. | G 3/8" | in-line | 2.5.1.1.15 | | | | | |
| MH 310 121 Ex dm | 3/2-way, single sol. | G 1/2" | in-line | 2.5.1.1.15 | | | | | |
| MOH 310 121 Ex dm | 3/2-way, n.o. single sol. | G 1/2" | in-line | 2.5.1.1.15 | | | | | |
| MH 320 501 Ex dm | 3/2-way, double sol. | G 1/8" | in-line | 2.5.1.1.18 | | | | | |
| MH 320 701 Ex dm | 3/2-way, double sol. | G 1/4" | in-line | 2.5.1.1.18 | | | | | |
| MH 320 801 Ex dm | 3/2-way, double sol. | G 1/4" | in-line | 2.5.1.1.18 | | | | | |
| MH 320 101 Ex dm | 3/2-way, double sol. | G 3/8" | in-line | 2.5.1.1.19 | | | | | |
| MH 320 121 Ex dm | 3/2-way, double sol. | G 1/2" | in-line | 2.5.1.1.19 | | | | | |
| MH 510 501 Ex dm | 5/2-way, single sol. | G 1/8" | in-line | 2.5.2.1.3 | | | | | |
| MH 510 701 Ex dm | 5/2-way, single sol. | G 1/4" | in-line | 2.5.2.1.3 | | | | | |
| MH 510 801 Ex dm | 5/2-way, single sol. | G 1/4" | in-line | 2.5.2.1.3 | | | | | |
| MH 510 101 Ex dm | 5/2-way, single sol. | G 3/8" | in-line | 2.5.2.1.4 | | | | | |
| MH 510 121 Ex dm | 5/2-way, single sol. | G 1/2" | in-line | 2.5.2.1.4 | | | | | |
| MH 520 501 Ex dm | 5/2-way, double sol. | G 1/8" | in-line | 2.5.2.1.9 | | | | | |
| MH 520 701 Ex dm | 5/2-way, double sol. | G 1/4" | in-line | 2.5.2.1.9 | | | | | |
| MH 520 801 Ex dm | 5/2-way, double sol. | G 1/4" | in-line | 2.5.2.1.9 | | | | | |
| MH 520 101 Ex dm | 5/2-way, double sol. | G 3/8" | in-line | 2.5.2.1.10 | | | | | |
| MH 520 121 Ex dm | 5/2-way, double sol. | G 1/2" | in-line | 2.5.2.1.10 | | | | | |
| MH 53_501 Ex dm | 5/3-way, different version | G 1/8" | in-line | 2.5.3.1.2 | | | | | |
| MH 53_701 Ex dm | 5/3-way, different version | G 1/4" | in-line | 2.5.3.1.2 | | | | | |
| MH 53_801 Ex dm | 5/3-way, different version | G 1/4" | in-line | 2.5.3.1.2 | | | | | |
| MH 53_101 Ex dm | 5/3-way, different version | G 3/8" | in-line | 2.5.3.1.3 | | | | | |
| MH 53_121 Ex dm | 5/3-way, different version | G 1/2" | in-line | 2.5.3.1.3 | | | | | |

Delivery contains valve with appropriate operator system, coil, manual and declaration of conformity.

ATEX-approved valves – Ex dm – low temperature range – aluminum

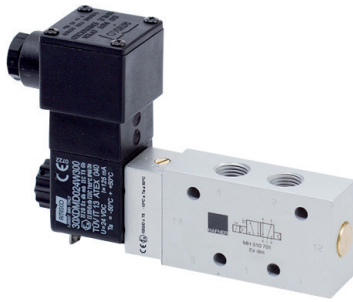

Material: Aluminum, anodized
 Zone: 1, 2, 21, 22
 Temperature range: -50°C ... +50°C ❄️
 Ignition protection type: Ex dm (encapsulated-flameproof with junction box)
 Temperature class: T5

Marking on valve:   II2G/D c T5 -50°C ≤ Ta ≤ 50°C

Base plate assembly due to width of solenoid coil (36 mm) is not possible.

Encapsulated flameproof solenoids are displayed on page 2.14.3.7.5.

The following **solenoid valves** are available:

| Type | Function | Port size | Installation | Further information on valve on page |
|-----------------------|----------------------------|-----------|--------------|--------------------------------------|
| MH 311 012 TT Ex dm | 3/2-way direct acting | M5 | in-line | 2.11.5.1.1 |
| MH 311 015 TT Ex dm | 3/2-way direct acting | G 1/8" | in-line | 2.11.5.1.1 |
| MH 310 501 TT Ex dm | 3/2-way, single sol. | G 1/8" | in-line | 2.11.5.1.2 |
| MOH 310 501 TT Ex dm | 3/2-way, n.o. single sol. | G 1/8" | in-line | 2.11.5.1.2 |
| MH 310 701 GTT Ex dm | 3/2-way, single sol. | G 1/4" | in-line | 2.11.5.1.2 |
| MOH 310 701 GTT Ex dm | 3/2-way, n.o. single sol. | G 1/4" | in-line | 2.11.5.1.2 |
| MH 320 501 TT Ex dm | 3/2-way, double sol. | G 1/8" | in-line | 2.11.5.1.2 |
| MH 320 701 GTT Ex dm | 3/2-way, double sol. | G 1/4" | in-line | 2.11.5.1.2 |
| MH 510 501 GTT Ex dm | 5/2-way, single sol. | G 1/8" | in-line | 2.11.5.2.1 |
| MH 510 701 GTT Ex dm | 5/2-way, single sol. | G 1/4" | in-line | 2.11.5.2.1 |
| MH 520 501 GTT Ex dm | 5/2-way, double sol. | G 1/8" | in-line | 2.11.5.2.2 |
| MH 520 701 GTT Ex dm | 5/2-way, double sol. | G 1/4" | in-line | 2.11.5.2.2 |
| MH 53_501 GTT Ex dm | 5/3-way, different version | G 1/8" | in-line | 2.11.5.2.2 |
| MH 53_701 GTT Ex dm | 5/3-way, different version | G 1/4" | in-line | 2.11.5.2.2 |

Valves with interface according to NAMUR-standard

| | | | | |
|----------------------|----------------------------|--------|------------|------------|
| MNH 310 701 TT Ex dm | 3/2-way, single sol. | G 1/4" | 1/4" NAMUR | 2.11.6.1 |
| MNH 510 701 TT Ex dm | 5/2-way, single sol. | G 1/4" | 1/4" NAMUR | 2.11.6.2.1 |
| MNH 510 711 TT Ex dm | 5/2-way, single sol. | G 1/4" | 1/4" NAMUR | 2.11.6.2.1 |
| MNH 520 701 TT Ex dm | 5/2-way, double sol. | G 1/4" | 1/4" NAMUR | 2.11.6.2.2 |
| MNH 53_701 TT Ex dm | 5/3-way, different version | G 1/4" | 1/4" NAMUR | 2.11.6.2.2 |

Delivery contains valve with the appropriate operator system, coil, manual and declaration of conformity.

ATEX-approved valves – Ex dm – standard temperature range – stainless steel

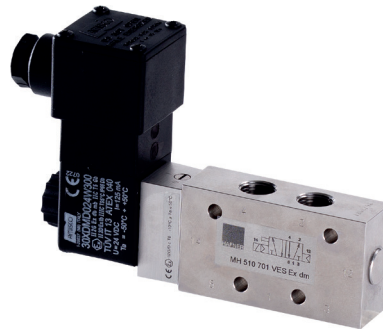

Material: Stainless steel, 316L 
 Zone: 1, 2, 21, 22
 Temperature range: -10°C ... +50°C
 Ignition protection type: Ex dm (encapsulated-flameproof with junction box)
 Temperature class: T5

Marking on valve:   II2G/D c T5 -10°C ≤ Ta ≤ 50°C

If the coil will be used with a NAMUR-valve of series 700, an 8 mm distance plate is required. Please contact us.

Encapsulated flameproof solenoids are displayed on page 2.14.3.7.5.

The following solenoid valves are available:

| Type | Function | Port size | Installation | Further information on valve on page |
|--|----------------------------|-----------|--------------|--------------------------------------|
| MH 311 015 VES Ex dm | 3/2-way direct acting | G 1/8" | in-line | 2.12.4.1 |
| MH 310 701 VES Ex dm | 3/2-way, single sol. | G 1/4" | in-line | 2.12.4.2 |
| MOH 310 701 VES Ex dm | 3/2-way, n.o. single sol. | G 1/4" | in-line | 2.12.4.2 |
| MH 310 121 VES Ex dm | 3/2-way, single sol. | G 1/2" | in-line | 2.12.4.3 |
| MOH 310 121 VES Ex dm | 3/2-way, n.o. single sol. | G 1/2" | in-line | 2.12.4.3 |
| MH 510 701 VES Ex dm | 5/2-way, single sol. | G 1/4" | in-line | 2.12.4.4 |
| MH 510 121 VES Ex dm | 5/2-way, single sol. | G 1/2" | in-line | 2.12.4.4 |
| MH 520 701 VES Ex dm | 5/2-way, double sol. | G 1/4" | in-line | 2.12.4.5 |
| MH 520 121 VES Ex dm | 5/2-way, double sol. | G 1/2" | in-line | 2.12.4.5 |
| MH 53_701 VES Ex dm | 5/3-way, different version | G 1/4" | in-line | 2.12.4.6 |
| MH 53_121 VES Ex dm | 5/3-way, different version | G 1/2" | in-line | 2.12.4.6 |
| Valves with interface according to NAMUR-standard | | | | |
| MNH 350 701 VES Ex dm | 3/2-way & 5/2-way | G 1/4" | 1/4" NAMUR | 2.12.5.3 |
| MNH 310 701 VES Ex dm | 3/2-way, single sol. | G 1/4" | 1/4" NAMUR | 2.12.5.1 |
| MNH 510 701 VES Ex dm | 5/2-way, single sol. | G 1/4" | 1/4" NAMUR | 2.12.5.2 |
| MNH 520 701 VES Ex dm | 5/2-way, double sol. | G 1/4" | 1/4" NAMUR | 2.12.5.2 |

Delivery contains valve with appropriate operator system, coil, manual and declaration of conformity.

ATEX-approved valves – Ex dm – low temperature range – stainless steel

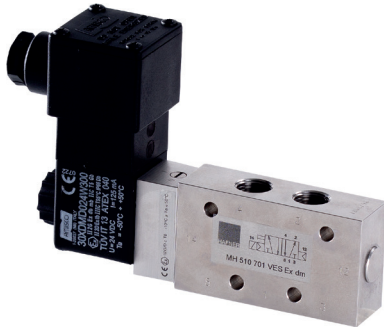

Material: Stainless steel, 316L 
 Zone: 1, 2, 21, 22
 Temperature range: -50°C ... +50°C ❄️
 Ignition protection type: Ex dm (encapsulated-
 flameproof with junction box)
 Temperature class: T5

Marking on valve:   II2G/D c T5 -50°C ≤ Ta ≤ 50°C

If the coil will be used with a NAMUR-valve of series 700,
 an 8 mm distance plate is required. Please contact us.

Encapsulated flameproof solenoids are displayed on
 page 2.14.3.7.5.

The following solenoid valves are available:

| Type | Function | Port size | Installation | Further information on valve on page |
|--------------------------|----------------------------|-----------|--------------|--------------------------------------|
| MH 311 015 VES TT Ex dm | 3/2-way direct acting | G 1/8" | in-line | 2.12.4.1 |
| MH 310 701 VES TT Ex dm | 3/2-way, single sol. | G 1/4" | in-line | 2.12.4.2 |
| MOH 310 701 VES TT Ex dm | 3/2-way, n.o. single sol. | G 1/4" | in-line | 2.12.4.2 |
| MH 510 701 VES TT Ex dm | 5/2-way, single sol. | G 1/4" | in-line | 2.12.4.4 |
| MH 520 701 VES TT Ex dm | 5/2-way, double sol. | G 1/4" | in-line | 2.12.4.5 |
| MH 53_701 VES TT Ex dm | 5/3-way, different version | G 1/4" | in-line | 2.12.4.6 |

Valves with interface according to NAMUR-standard

| | | | | |
|--------------------------|----------------------|--------|------------|----------|
| MNH 350 701 VES TT Ex dm | 3/2-way & 5/2-way | G 1/4" | 1/4" NAMUR | 2.12.5.3 |
| MNH 310 701 VES TT Ex dm | 3/2-way, single sol. | G 1/4" | 1/4" NAMUR | 2.12.5.1 |
| MNH 510 701 VES TT Ex dm | 5/2-way, single sol. | G 1/4" | 1/4" NAMUR | 2.12.5.2 |
| MNH 520 701 VES TT Ex dm | 5/2-way, double sol. | G 1/4" | 1/4" NAMUR | 2.12.5.2 |

When this solenoid system is used in combination with "ATEX certified" mechanical components conforming EN 13463-1:2001 and PrEN 13463-5:2000, the entire valve can be used in explosive hazardous environment zone 1, 2, 21 and 22.

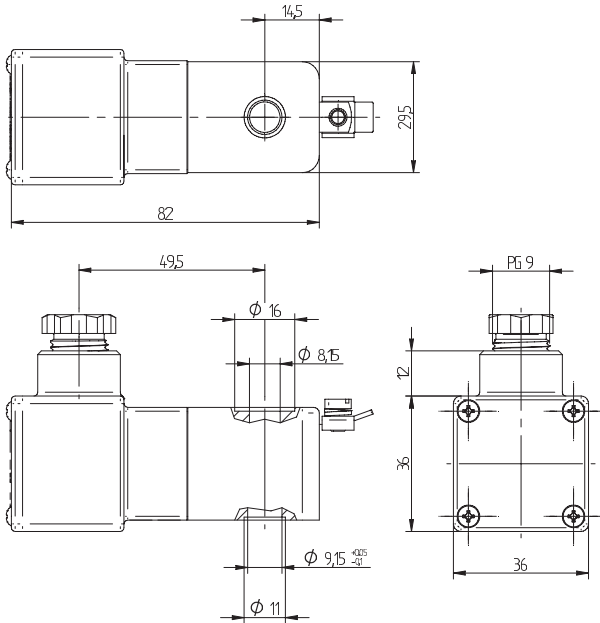

MA 36 EEx dm IIC T5_ _



ATEX approved encapsulated coil with flameproof junction box for gas and dust explosion-hazardous environment.

Voltages: 12VDC, 24VDC, 24VAC, 110VAC, 230VAC

Voltage tolerance: - 10...+ 10%

Relative duty cycle: 100 %

Temperature range: -50°C...+50°C

Ignition protection type: Coil encapsulated, junction box flameproof

Protection with connector according to EN 60529: IP 66

Moulding material: Thermoplasticpolyester

Coil rating according to DIN VDE 0580: Class F

Cable Gland: PG 9 DIN 40-430 for cable diameters 6 – 8 mm

Marking on coil:  II 2G Ex db mb IIC T5 Gb
II 2D Ex tb IIIC T95°C IP66 Db

As the coil is 36 mm wide, a spacer plate called "ZPN 8" has to be used, in case of combination with our NAMUR-valve series 700. If used with NAMUR-valve series 121 a spacer plate called "ZPN 6-5" has to be used. You can find both plates on page 2. 10. 12.

The ATEX approval is only valid as long as the associated components are used.

| Type | Operating press. | Power cons. | Temperature class |
|----------------------------|------------------|-------------|-------------------|
| MA 36 EEx dm IIC T5 12 DC | max. 10 bar | 3,0 Watt | T5 (100 °C) |
| MA 36 EEx dm IIC T5 24 DC | max. 10 bar | 3,0 Watt | T5 (100 °C) |
| MA 36 EEx dm IIC T5 24 AC | max. 10 bar | 4,8 VA | T5 (100 °C) |
| MA 36 EEx dm IIC T5 110 AC | max. 10 bar | 4,8 VA | T5 (100 °C) |
| MA 36 EEx dm IIC T5 230 AC | max. 10 bar | 4,8 VA | T5 (100 °C) |

CBN 700 K Ex/ CBN 700 K EB Ex

Controlblock for butterfly valves with inflatable valve-seat

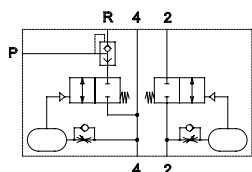

CBN 700 K Ex

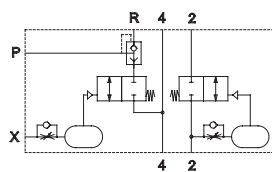

CBN 700 K EB Ex



Control block for double acting actuators with interface according to 1/4" NAMUR-standard, to be used on process-valves with inflatable valve seat.

The control-block receives it's signals to open and close from a standard 5/2-way NAMUR-valve. The block is to be put between the actuator and the NAMUR-valve (flange-version). The closing-signal is fed through to the actuator, the seal is inflated with time-delay.

When the process-valves is to be closed first the seal is deflated, with time-delay the actuator opens the process-valve.

Opening- and closing-time-delay can be adjusted independently but they are related to the operating pressure.

At 6 bar time-delay can be adjusted between 0 and 2 seconds.

Type **CBN 700 K EB Ex** with additional port X: pressurizing of the inflatable seal does not start before a pneumatic signal is received.

If the valve is required with G 1/4" ports, plate GPN 1/4 can be added. For details please refer to page 2.10.12.

Delivery includes 2 screws, 2 O-rings, 2 protection caps.

Please note:

If a pressure regulator is used between the CBN 700 (port P) and the inflatable seal, an additional quick exhaust valve is needed to exhaust the seal.

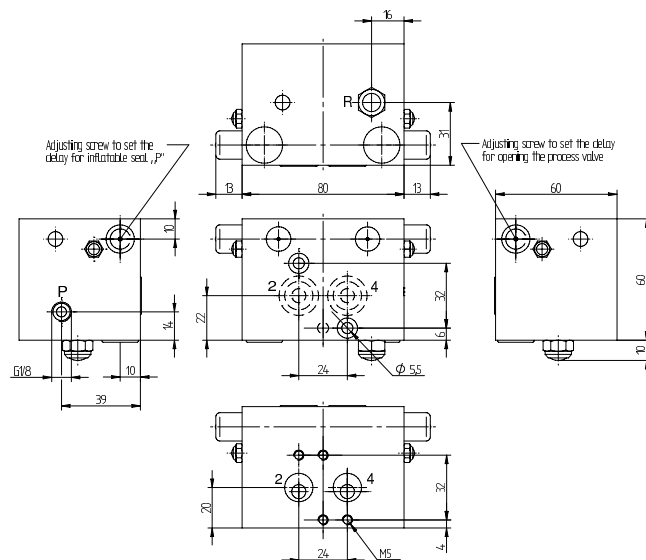

CBN 700 K Ex

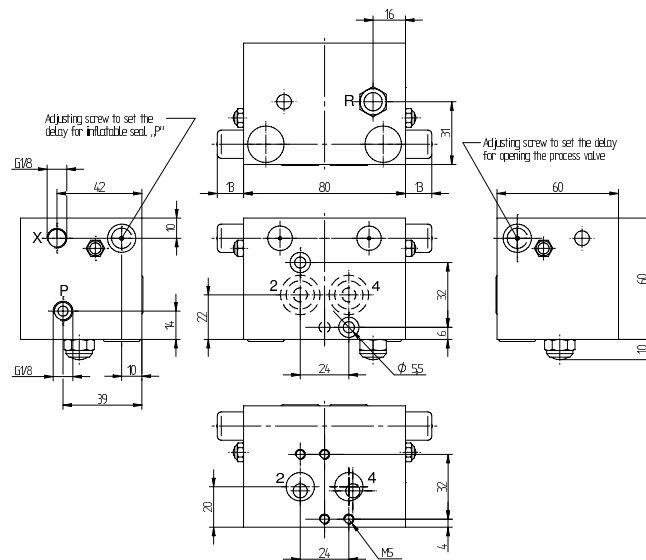

CBN 700 K EB Ex

Marking on valve:

CE Ex II3G/D c T6 -10°C ≤ Ta ≤ 50°C

Zone: 2 and 22

| Type | NAMUR | Port P | Port X | Air flow act. | Operating press. | Air flow seal | Weight |
|-----------------|-------|--------|--------|---------------|------------------|---------------|---------|
| CBN 700 K Ex | 1/4" | G 1/8" | | 900 l/min | 3 - 10 bar | 400 l/min | 0,80 kg |
| CBN 700 K EB Ex | 1/4" | G 1/8" | G 1/8" | 900 l/min | 3 - 10 bar | 400 l/min | 0,80 kg |

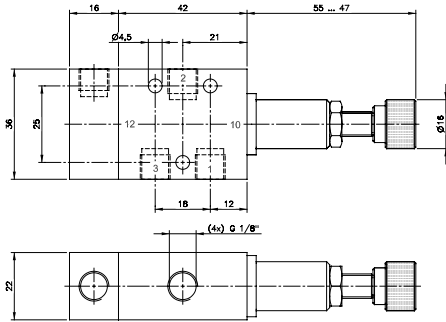

P 311 501 SR Ex

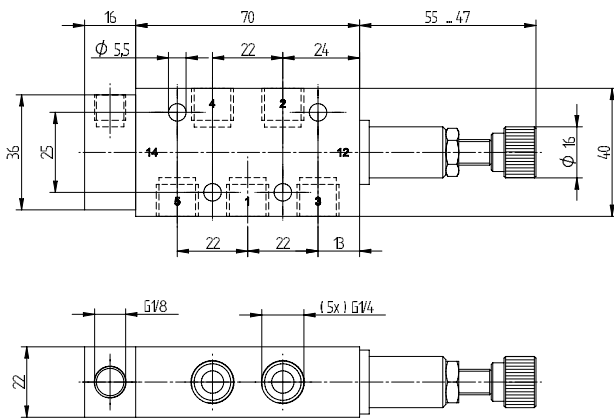

P 411 701 SR Ex

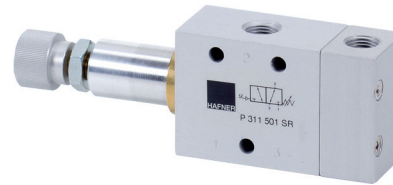

P 311 501 SR pneumatically actuated 3/2-way valve with mechanical spring return. Valve can be used normally closed (pressure at port 1) and normally open (pressure at port 3). Can also be used as 2/2-way valve. Unused port to be closed by silencer or plug.

P 411 701 SR pneumatically actuated 4/2-way valve with mechanical spring return. Valve either blocks all ports or is open from 1 to 4 and from 3 to 2. Port 5 is a vent port and should have a silencer installed.

Valve can be used as an **adjustable pneumatic pressure switch**. By turning the hand-wheel the required minimum actuation pressure can be set between 3 and 6 bar. Adjustment is not independent from operation pressure.

Please take care about the hysteresis of the spring.

Marking von valve:

CE Ex II 3G/D c T6 -10°C ≤ Ta ≤ 50°C

Zone: 2 and 22

| Type | Port size | Air flow | Operating press. | Regulating range act. press. | Max. act. press. | Weight |
|-----------------|-----------|------------|------------------|------------------------------|------------------|---------|
| P 311 501 SR Ex | G 1/8" | 650 l/min | 2 - 10 bar | 3 - 6 bar | 10 bar | 0,16 kg |
| P 411 701 SR Ex | G 1/4" | 1250 l/min | 2 - 10 bar | 3 - 6 bar | 10 bar | 0,21 kg |

SENR 207 01 Ex

Quick-exhaust-block with non-return valve

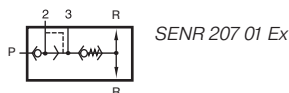

The valve is designed for fast closing of spring-return actuators with 1/4" NAMUR-interface.

Any 3/2-way valve can be used as pilot valve. The connection towards the pilot valve is G 1/4" ported and for NAMUR-valves with the 1/4" NAMUR-interface.

The block assures that only compressed air that has been used to open the actuator is used in the spring-chamber (non-return-function). Excess air is released very fast by the quick-exhaust valve, exhaust-port G 1/2", orifice 10 mm. The non-return valve makes absolutely sure that no ambient atmosphere can be sucked into the actuator.

Two exhaust-ports R allow that the product can always be assembled so the silencer faces downwards.

Delivery includes 2 screws, 2 O-rings, 1/2" plug for port R.

Marking von valve:

CE $\text{\textcircled{EX}}$ II 3G/D c T6 -10°C ≤ Ta ≤ 50°C

Zone: 2 and 22

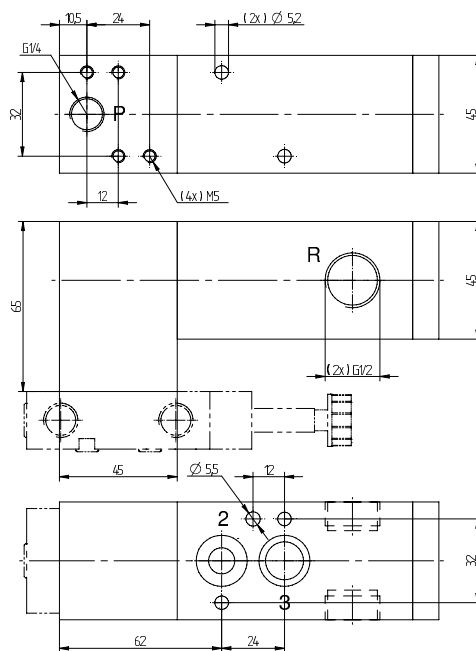

SENR 207 01 Ex

Function:

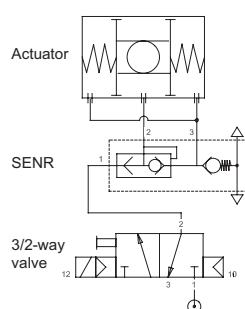

| Type | NAMUR Port P | Port R | Air flow P to 2 | Air flow exhaust | Operating press. | Weight |
|----------------|--------------|---------------------|-----------------|------------------|------------------|--------------------|
| SENR 207 01 Ex | 1/4" | G 1/4" - 1/4" NAMUR | G 1/2" | 1250 l/min | 2500 l/min | 2 - 10 bar 0,85 kg |

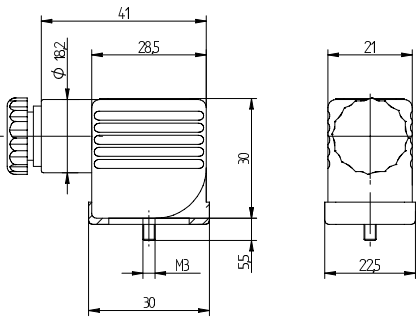
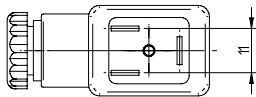

ST 22 Ex

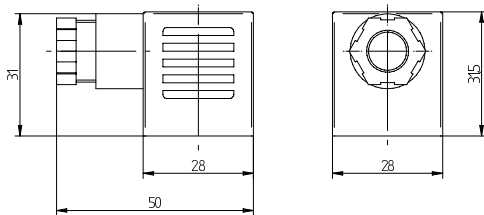
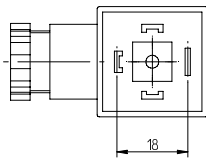

ST 30 Ex ia / ST 30 Ex nA



Connectors as accessories for explosion-proof coils.

Type ST 22 Ex

Connector to be used in combination with MA 22 Ex nA. Connector is classified for zone 2 and 22 cat. IIG/D. Includes flat seal.

Type ST 30 Ex ia

Connector which is to be used in combination with the coil type MA 30 Ex ia tD II CT6 24DC. Connector has no separate ATEX certification. Connector is classified for zone 21, cat. IID. Can also be used in combination with intrinsically safe coils in zone 1 (cat. IIG). Includes flat silicon seal.

Type ST 30 Ex nA

Connector to be used in combination with MA 30 Ex na. Connector is classified for zone 2 and 22, cat. IIIG and IIID. Includes profiled NBR seal.

Other connectors are available on request.

| Type | Form | LED | VAR | Operat. voltage | Max. current | Cable diameter |
|-------------|-------------|-----|-----|-----------------|--------------|----------------|
| ST 22 Ex | Industrial | no | no | 0 - 250 V | 10 A | 6 - 8 mm |
| ST 30 Ex ia | A, ISO 4400 | no | no | 0 - 250 V | 10 A | 6 - 8 mm |
| ST 30 Ex nA | A, ISO 4400 | no | no | 0 - 250 V | 10 A | 4 - 8 mm |



HAFNER

aim fluid control sinds 1995. Als onafhankelijke specialist in het meten en regelen van diverse soorten vloeistof- en gasstromen (Flow & Fluid Technology) richt aim zich op de professionele markt. De markt met de behoefte aan standaardproducten tot aan engineeringprojecten die verregaande technische kennis vereisen op het gebied van afsluiters, magneetventielen, pneumatiek ventielen, actuators, appendages, vacuümpompen, compressoren, fittingen en toebehoren.

Vanuit het hoofdkantoor en magazijn te Son & Breugel, nabij Science Park Ekkersrijt, ontzorgt aim zijn klanten van A tot Z en biedt technische en logistieke maatwerkoplossingen door gedegen kennis, een gedreven en persoonlijke service én een klantspecifiek voorraadbeheer.

Ontzorgend, **Betrokken** & **Verantwoordelijk**

aim fluid control b.v.
Ekkersrijt 7310-7312
5692 HH Son en Breugel / Nederland
T. +31(0) 499 49 10 90
E. info@aimfluid.nl
F. +31(0) 499 49 63 70
I. www.aimfluid.nl

Hafner-Pneumatik Krämer KG
Stammheimer Straße 10
D-70806 Kornwestheim
T. +49 - 71 54 - 17 85 890
F. +49 - 71 54 - 17 85 89 28
E. info@hafner-pneumatik.de
I. www.hafner-pneumatik.de

